

**Features**

- Glass Passivated Die Construction
- Super-Fast Recovery Time For High Efficiency
- Low Forward Voltage Drop and High Current Capability
- Surge Overload Rating to 70A Peak
- Ideally Suited for Automated Assembly
- Plastic Material: UL Flammability Classification Rating 94V-0

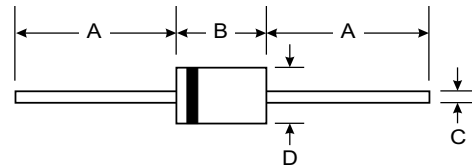

**Mechanical Data**

- Case: Molded Plastic
- Terminals: Solder Plated Terminal - Solderable per MIL-STD-202, Method 208
- Marking: R460
- Polarity: Cathode Band
- Weight: 1.12 grams (approx.)
- Mounting Position: Any

DO-201AD		
Dim	Min	Max
A	25.40	—
B	7.20	9.50
C	1.20	1.30
D	4.80	5.30
All Dimensions in mm		

**Maximum Ratings and Electrical Characteristics**

@ T<sub>A</sub> = 25°C unless otherwise specified

Single phase, half wave, 60Hz, resistive or inductive load.  
For capacitive load, derate current by 20%.

Characteristic	Symbol	MUR460	Unit
Peak Repetitive Reverse Voltage Working Peak Reverse Voltage DC Blocking Voltage	V <sub>RRM</sub> V <sub>RWM</sub> V <sub>R</sub>	600	V
RMS Reverse Voltage	V <sub>R(RMS)</sub>	424	V
Average Rectified Output Current @ T <sub>T</sub> = 40°C	I <sub>O</sub>	4.0	A
Non-Repetitive Peak Forward Surge Current 8.3ms Single half sine-wave Superimposed on Rated Load (JEDEC Method)	I <sub>FSM</sub>	70	A
Forward Voltage @ I <sub>F</sub> = 3.0A, T <sub>J</sub> = 150°C @ I <sub>F</sub> = 3.0A, T <sub>J</sub> = 25°C @ I <sub>F</sub> = 4.0A, T <sub>J</sub> = 25°C	V <sub>FM</sub>	1.05 1.25 1.28	V
Peak Reverse Current at Rated DC Blocking Voltage @ T <sub>A</sub> = 25°C @ T <sub>A</sub> = 150°C	I <sub>RM</sub>	10 250	μA
Reverse Recovery Time (Note 2)	t <sub>rr</sub>	50	ns
Forward Recovery Time (Note 3)	t <sub>fr</sub>	50	ns
Typical Junction Capacitance (Note 1)	C <sub>j</sub>	75	pF
Typical Thermal Resistance, Junction to Ambient (Note 4)	R <sub>θJA</sub>	52	K/W
Operating and Storage Temperature Range	T <sub>j</sub> , T <sub>STG</sub>	-65 to +175	°C

- Notes:
1. Measured at 1.0MHz and applied reverse voltage of 4V DC.
  2. Measured with I<sub>F</sub> = 0.5A, I<sub>R</sub> = 1.0A, I<sub>rr</sub> = 0.25A. See Figure 5.
  3. Measured with I<sub>F</sub> = 1.0A, di/dt = 100A/μs, Duty Cycle ≤ 2.0%.
  4. Mounted to PCB, lead length = 9.5mm.

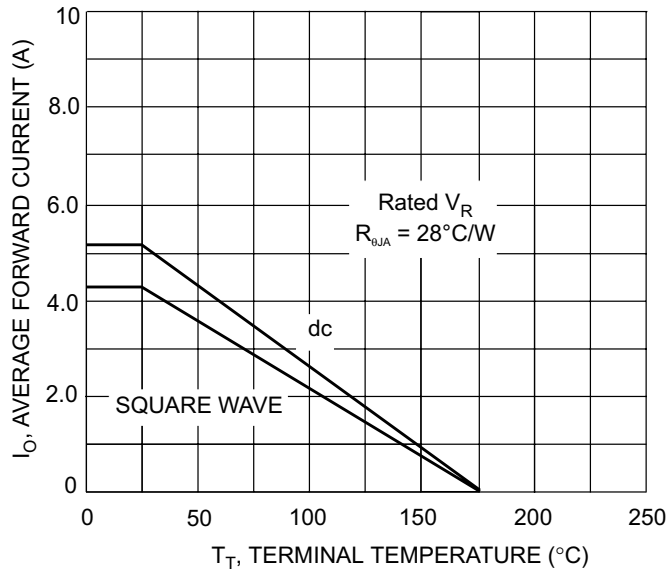

Fig. 1 Forward Current Derating Curve

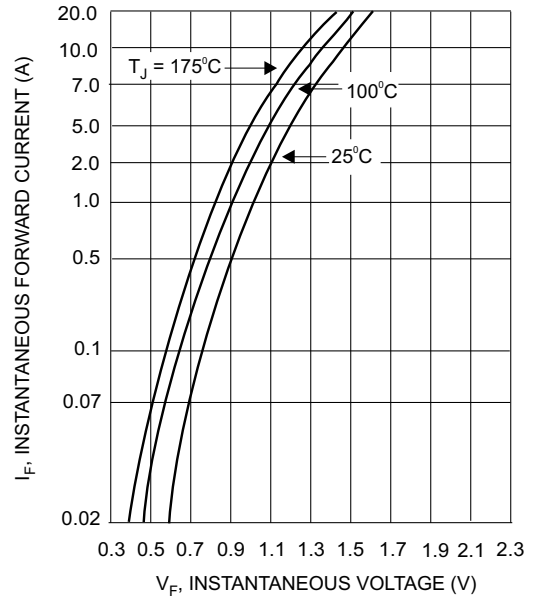

Fig. 2 Typical Forward Characteristics

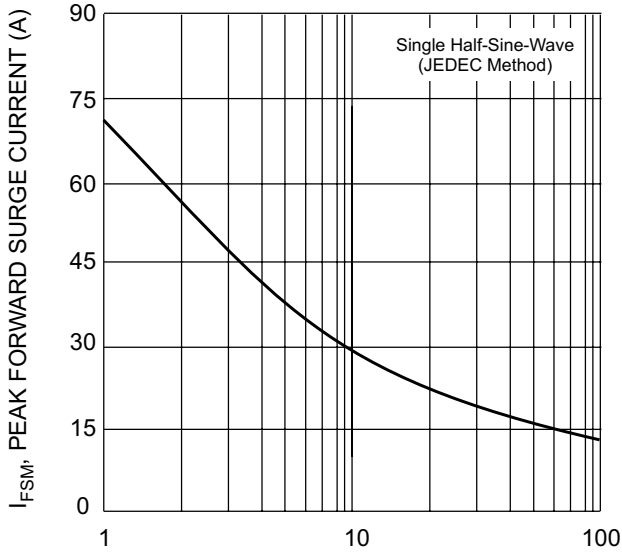

Fig. 3 Surge Current Derating Curve

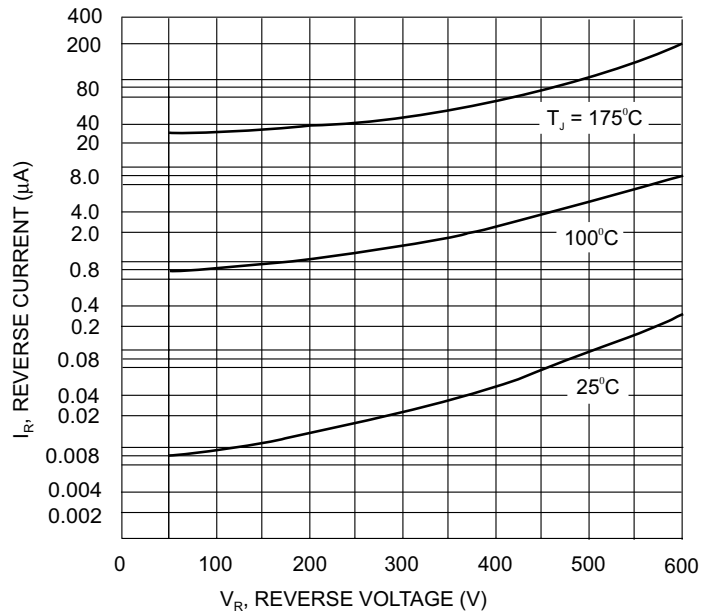
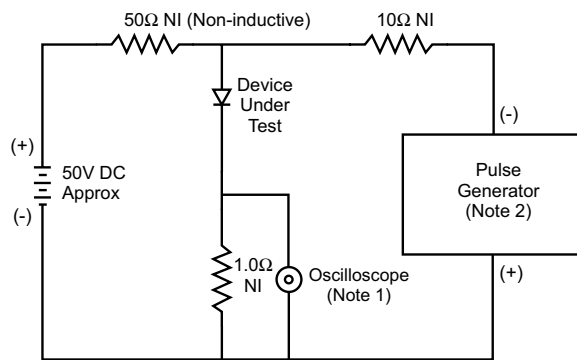
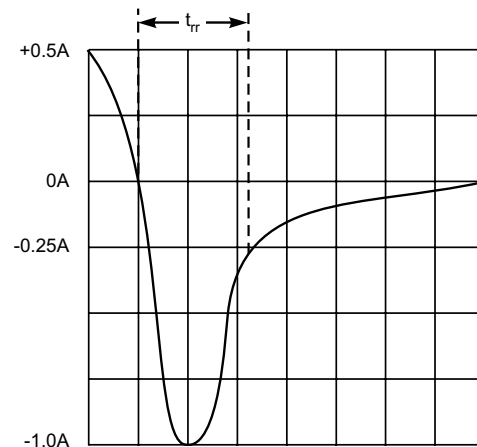

Fig. 4 Typical Reverse Characteristics



- Notes:
1. Rise Time = 7.0ns max. Input Impedance = 1.0MΩ, 22pF.
  2. Rise Time = 10ns max. Input Impedance = 50Ω.



Set time base for 50/100 ns/cm

Fig. 5 Reverse Recovery Time Characteristic and Test Circuit