

RTL8019AS

Realtek Full-Duplex Ethernet Controller with Plug and Play Function (RealPNP)

SPECIFICATION

REALTEK SEMI-CONDUCTOR CO., LTD.

HEAD OFFICE

*NO. 2, INDUSTRY E. RD. IX, SCIENCE-BASED
INDUSTRIAL PARK, HSINCHU 30077, TAIWAN, R.O.C.
TEL: 886-3-5780211 FAX: 886-3-5776598*

OFFICE

*3F, NO. 56, WU-KUNG 6 RD.,
TAIPEI HSIEN, TAIWAN, R.O.C.
TEL: 886-2-22980098 FAX: 886-2-22980094, 22980097*

CONTENTS

1. FEATURES	3
2. GENERAL DESCRIPTION	4
3. PIN CONFIGURATION	5
4. PIN DESCRIPTION	
4.1. Power Pins	6
4.2. ISA Bus Interface Pins	6
4.3. Memory Interface Pins (including BROM, EEPROM).....	7
4.4. Medium Interface Pins	8
4.5. LED Output Pins	8
5. REGISTER DESCRIPTIONS	
5.1. Group 1: NE2000 Registers	9
5.1.1. Register Table	9
5.1.2. Register Functions	11
5.1.2.1. NE2000 Compatible Registers	11
5.1.2.2. RTL8019AS Defined Registers	16
5.2. Group 2: Plug and Play (PnP) Registers	23
5.2.1. Card Control Registers	24
5.2.2. Logical Device Control Registers	25
5.2.3. Logical Device Configuration Registers	25
6. FUNCTIONAL DESCRIPTIONS	
6.1. RTL8019AS Configuration Modes	27
6.2. Plug and Play	29
6.2.1. Initiation Key	29
6.2.2. Isolation Protocol	30
6.2.3. Plug and Play Isolation Sequence	34
6.2.4. Reading Resource Data	35
6.2.5. PnP auto detect mode	36
6.3. 9346 Contents	37
6.4. Boot ROM	38
6.5. LED Behaviors	40
6.6. Loopback Diagnostic Operation	42
6.6.1. Loopback Operation	42
6.6.2. To implement Loopback Test.....	43
7. Electrical Specification and Timings	
7.1. Absolute Maximum Ratings	46
7.2. D.C. Characteristics	46
7.3. A.C. Timing Characteristics	46

1. FEATURES

- 100-pin PQFP
- RTL8019 software compatible
- Supports PnP auto detect mode (RTL8019AS only)
- Compliant to Ethernet II and IEEE802.3 10Base5, 10Base2, 10BaseT
- Software compatible with NE2000 on both 8 and 16-bit slots
- Supports both jumper and jumperless modes
- Supports Microsoft's Plug and Play configuration for jumperless mode
- Supports Full-Duplex Ethernet function to double channel bandwidth
- Supports three level power down modes:
 - Sleep
 - Power down with internal clock running
 - Power down with internal clock halted
- Built-in data prefetch function to improve performance
- Supports UTP, AUI & BNC auto-detect (RTL8019AS only)
- Supports auto polarity correction for 10BaseT
- Support 8 IRQ lines
- Supports 16 I/O base address options
 - and extra I/O address fully decode mode (RTL8019AS only)
- Supports 16K, 32K, 64K and 16K-page mode access to BROM (up to 256 pages with 16K bytes/page)
- Supports BROM disable command to release memory after remote boot
- Supports flash memory read/write (RTL8019AS only)
- 16k byte SRAM built in (RTL8019AS only)
- Use 9346 (64*16-bit EEPROM) to store resource configurations and ID parameters
- Capable of programming blank 9346 on board for manufacturing convenience
- Support 4 diagnostic LED pins with programmable outputs

2. General Description

The RTL8019AS is a highly integrated Ethernet Controller which offers a simple solution to implement a Plug and Play NE2000 compatible adapter with full-duplex and power down features. With the three level power down control features, the RTL8019AS is made to be an ideal choice of the network device for a GREEN PC system. The full-duplex function enables simultaneously transmission and reception on the twisted-pair link to a full-duplex Ethernet switching hub. This feature not only increases the channel bandwidth from 10 to 20 Mbps but also avoids the performance degrading problem due to the channel contention characteristics of the Ethernet CSMA/CD protocol. The Microsoft's Plug and Play function can relieve the users from pains of taking care the adapter's resource configurations such as IRQ, I/O, and memory address, etc. However, for special applications not to be used as a Plug and Play compatible device, the RTL8019AS also supports the jumper and proprietary jumperless options.

To offer a fully *plug and play* solution, the RTL8019AS provides the auto-detect capability between the integrated 10BaseT transceiver, BNC and AUI interface. Besides, the 10BaseT transceiver can automatically correct the polarity error on its receiving pair. Furthermore, 8 IRQ lines and 16 I/O base address options are provided for grand resource configuration flexibility.

The RTL8019AS supports 16k, 32k & 64k byte BROM and flash memory interface. It also offers the page mode function which can support up to 4M-byte BROM within only 16k-byte system memory space. Besides, the BROM disable command is provided to release the BROM memory space for other system usage (e.g. EMM386, etc.) after the BROM program is loaded.

The RTL8019AS is built in with 16K-byte SRAM in a single chip. It is designed not only to provide more friendly functions but also to save the effort of SRAM sourcing and inventory.

3. PIN CONFIGURATION

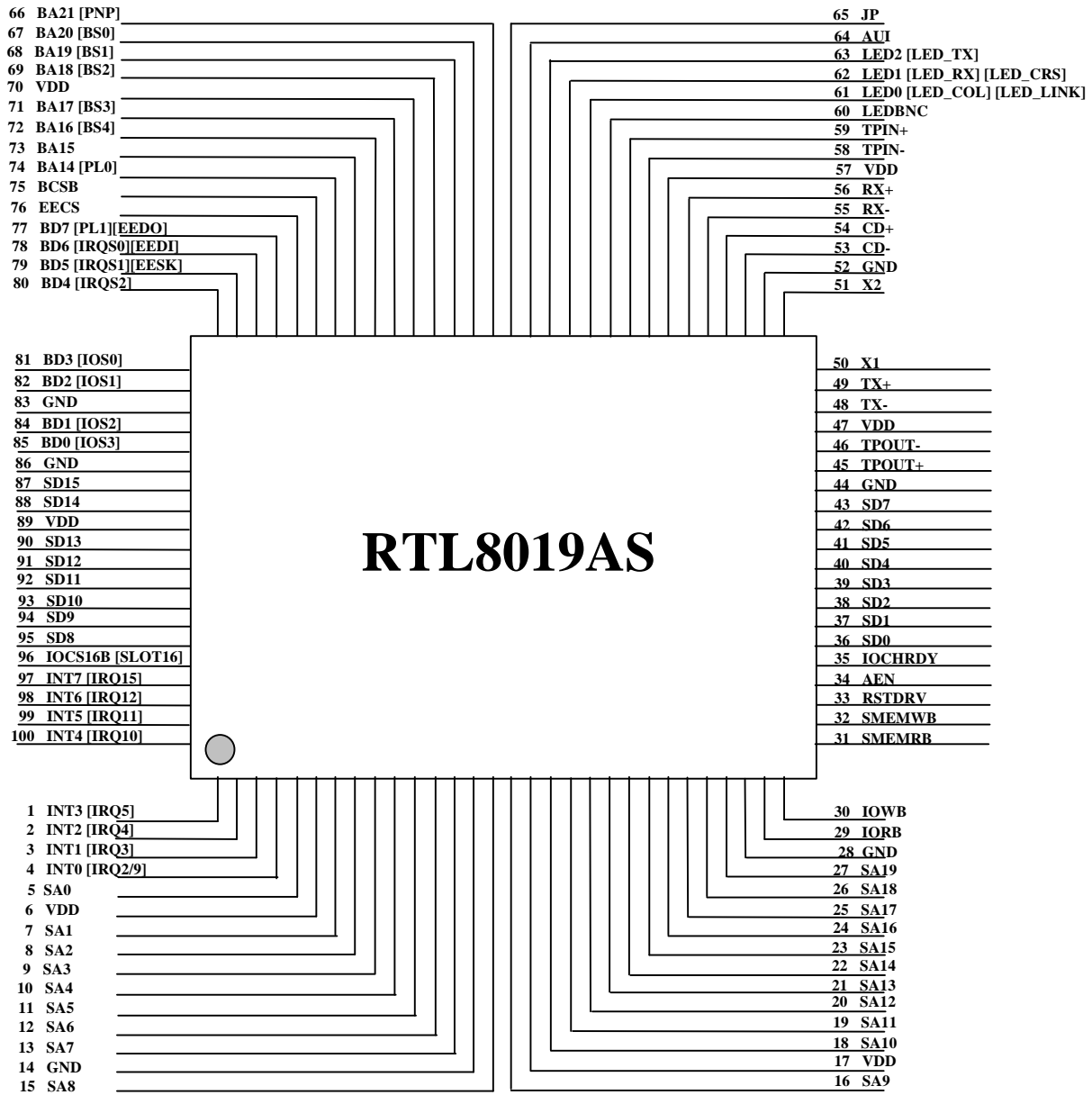

4. PIN DESCRIPTIONS

4.1. Power Pins

No.	Name	Type	Description
6, 17, 47, 57, 70, 89	VDD	P	+5V DC power
14, 28, 44, 52, 83, 86	GND	P	Ground

4.2. ISA Bus Interface Pins

No.	Name	Type	Descriptions
34	AEN	I	Address Enable. This ISA signal must be low for a valid I/O command.
97-100, 1-4	INT7-0	O	Interrupt request lines which are mapped to IRQ15, IRQ12, IRQ11, IRQ10, IRQ5, IRQ4, IRQ3, IRQ2/9 respectively. Only one line is selected to reflect the interrupt requests at one time. All other lines are tri-stated. The RTL8019AS also uses these pins as inputs to monitor the actual state of the corresponding interrupt lines on ISA bus. The result is recorded in the INTR register, which may be used by software to detect interrupt conflict.
35	IOCHRDY	O	This ISA signal is driven low to insert wait cycles to current host read/write command.
96	IOCS16B [SLOT16]	O	Upon power-on reset, this pin acts as an input named SLOT16 to detect whether a 16-bit or 8-bit slot is in use. To do this, it is connected to a pull-down resistor (about 27KW) externally. At the falling edge of RSTDRV, the RTL8019AS senses this pin's state. If it is sensed high, the adapter is thought to be placed on a 16-bit slot where this pin is connected to the host's IOCS16B pin, which is typically pulled up by a 300W resistor on the mother board. If it is sensed low, the adapter is thought to be placed on an 8-bit slot where this pin is merely pulled low by the 27KW resistor. After having latched the input state, this pin is switched as the IOCS16B signal which is an open-drain output and is driven low during a 16-bit host data transfer. It is decoded from AEN and SA9-0.
29	IORB	I	Host I/O read command.
30	IOWB	I	Host I/O write command.
33	RSTDRV	I	High active hardware reset signal from the ISA bus. Pulses with high level less than 800ns are ignored.
27-18, 16-15, 13-7, 5	SA19-0	I	Host address bus. SA10 is added to implement the fully decode of PnP ports, address 279h and A79h. In RTL8019, SA10 is not decoded. In RTL8019AS, SA10 should be 0 for a valid access to PnP ports.
87-88, 90-95, 43-36	SD15-0	I/O	Host data bus.

31	SMEMRB	I	Host memory read command.
32	SMEMWB	I	Host memory write command. This pin is added to decode the write command of a flash memory.

4.3. Memory Interface Pins (including BROM, EEPROM)

No.	Name	Type	Description
75	BCSB	O	BROM chip select. Active low signal, asserted when BROM is read. RTL8019AS drives this pin low when SA19-14 matches the selected BROM memory base address and either of the 2 conditions below meets: (1) SMEMRB is low (2) SMEMWB is low and RTL8019AS's flash memory write function is enabled.
76	EECS	O	9346 chip select. Active high signal, asserted when 9346 is read/write.
66-69, 71-74 77-82, 84-85	BA21-14 BD7-0	O I/O	BROM address. BROM data bus.
[79]	[EESK]	O	9346 serial data clock
[78]	[EEDI]	O	9346 serial data input
[77]	[EEDO]	I	9346 serial data output
[66]	[PNP]	I	The following pins are defined for jumper options. Their states are latched at the falling edge of RSTDRV, then they are changed to serve as the SRAM bus. Each of them is internally pulled down by a 100KΩ resistor. Therefore, the input will be low when left open and high when pulled up by a 10K resistor externally. When it is high in jumperless mode (i.e. JP=low), the RTL8019AS is forced into Plug and Play mode regardless of the contents of 9346. The following pins are don't care in jumperless mode (JP=low).
[72-71, 69-67]	[BS4-0]	I	Select BROM size and base address.
[85-84, 82-81]	[IOS3-0]	I	Select I/O base address.
[77, 74]	[PL1-0]	I	Select network medium type.
[80-78]	[IRQS2-0]	I	Select one interrupt line among INT7-0.
65	JP	I	When high, this pin selects jumper mode. When low, it selects jumperless modes (including RT jumperless and Plug and Play).

After RTL8019AS latches all jumper status upon power on reset, these pins *always** reflect the value of BPAGE register directly in BROM page mode. In normal mode, BA16-21 are not used and BA14-15 act as:

BROM Size	BA14	BA15
16K	high	high
32K	SA14	high
64K	SA14	SA15

*Note: RTL8019AS doesn't drive BA14-21 until the SMEMRB goes from high to low.

4.4. Medium Interface Pins

No.	Name	Type	Description
64	AUI	I	This input is used to detect the usage of an external MAU on the AUI interface. The input should be driven low for embedded BNC and high for external MAU. When the input is high, RTL8019AS sets the AUI bit (bit5) in CONFIG0 and drives LEDBNC low to disable the BNC. If this pin is not used, it should be connected to GND such that RTL8019AS acts like RTL8019. Please refer to section 5.1.2.2. CONFIG0 for more details.
54,53	CD+,CD-	I	This AUI collision input pair carries the differential collision input signal from the MAU.
56,55	RX+,RX-	I	This AUI receive input pair carries the differential receive input signal from the MAU.
49,48	TX+,TX-	O	This AUI transmit output pair contains differential line drivers which send Manchester encoded data to the MAU. These outputs are source followers and require 270 ohm pull-down resistors to GND.
59,58	TPIN+, TPIN-	I	This TP input pair receives the 10 Mbits/s differential Manchester encoded data from the twisted-pair wire.
45,46	TPOUT+, TPOUT-	O	This pair carries the differential TP transmit output. The output Manchester encoded signals have been pre-distorted to prevent overcharge on the twisted-pair media and thus reduce jitter.
50	X1	I	20Mhz crystal or external oscillator input.
51	X2	O	Crystal feedback output. This output is used in crystal connection only. It must be left open when X1 is driven with an external oscillator.

4.5. LED Output Pins

No.	Name	Type	Description
60	LEDBNC	O	This pin goes high when RTL8019AS's medium type is set to 10Base2 mode or auto-detect mode with link test failure. Otherwise, this pin is low. This pin can be used to control the power of the DC convertor for CX MAU and connected to an LED to indicate the used medium type.
61	LED0	O	When LEDS0 bit (in CONFIG3 register of RTL8019AS Page3) is 0, this pin acts as LED_COL. When LEDS0=1, it acts as LED_LINK.

62,63	LED1,LED2	O	When LEDS1 bit (in CONFIG3 register of RTL8019AS Page3) is 0, these 2 pins act as LED_RX & LED_TX respectively. When LEDS1=1, these pins act as LED_CRS & MCSB. Please refer to section 6.5 for details of the lightening behavior of all LEDs.
-------	-----------	---	---

5. Register Descriptions

The registers in RTL8019AS can be roughly divided into two groups by their address and functions -- one for NE2000, the other for Plug and Play (PnP).

5.1. Group 1: NE2000 Registers

This group includes 4 pages of registers which are selected by bit PS0 & PS1 in the CR register. Each page contains 16 registers. Besides those registers compatible with NE2000, the RTL8019AS defines some registers for software configuration and feature enhancement.

5.1.1. Register Table

No (Hex)	Page0		Page1	Page2	Page3	
	[R]	[W]	[R/W]	[R]	[R]	[W]
00	CR	CR	CR	CR	CR	CR
01	CLDA0	PSTART	PAR0	PSTART	<i>9346CR</i>	<i>9346CR</i>
02	CLDA1	PSTOP	PAR1	PSTOP	<i>BPAGE</i>	<i>BPAGE</i>
03	BNRY	BNRY	PAR2	-	<i>CONFIG0</i>	-
04	TSR	TPSR	PAR3	TPSR	<i>CONFIG1</i>	<i>CONFIG1</i>
05	NCR	TBCR0	PAR4	-	<i>CONFIG2</i>	<i>CONFIG2</i>
06	FIFO	TBCR1	PAR5	-	<i>CONFIG3</i>	<i>CONFIG3</i>
07	ISR	ISR	CURR	-	-	<i>TEST</i>
08	CRDA0	RSAR0	MAR0	-	<i>CSNSAV</i>	-
09	CRDA1	RSAR1	MAR1	-	-	<i>HLTCLK</i>
0A	<i>8019ID0</i>	RBCR0	MAR2	-	-	-
0B	<i>8019ID1</i>	RBCR1	MAR3	-	<i>INTR</i>	-
0C	RSR	RCR	MAR4	RCR	-	<i>FMWP</i>
0D	CNTR0	TCR	MAR5	TCR	<i>CONFIG4</i>	-
0E	CNTR1	DCR	MAR6	DCR	-	-
0F	CNTR2	IMR	MAR7	IMR	-	-
10-17	Remote DMA Port					
18-1F	Reset Port					

Notes: "-" denotes reserved. Registers with names typed in ***bold italic*** format are RTL8019AS defined registers and are not supported in a standard NE2000 adapter.

Page 0 (PS1=0, PS0=0)

No.	Name	Type	Bit 7	Bit 6	Bit 5	Bit 4	Bit 3	Bit 2	Bit 1	Bit 0
00H	CR	R/W	PS1	PS0	RD2	RD1	RD0	TXP	STA	STP
01H	CLDA0	R	A7	A6	A5	A4	A3	A2	A1	A0
	PSTART	W	A15	A14	A13	A12	A11	A10	A9	A8
02H	CLDA1	R	A15	A14	A13	A12	A11	A10	A9	A8
	PSTOP	W	A15	A14	A13	A12	A11	A10	A9	A8
03H	BNRY	R/W	A15	A14	A13	A12	A11	A10	A9	A8
04H	TSR	R	OWC	CDH	0	CRS	ABT	COL	-	PTX
	TPSR	W	A15	A14	A13	A12	A11	A10	A9	A8
05H	NCR	R	0	0	0	0	NC3	NC2	NC1	NC0
	TBCR0	W	TBC7	TBC6	TBC5	TBC4	TBC3	TBC2	TBC1	TBC0
06H	FIFO	R	D7	D6	D5	D4	D3	D2	D1	D0
	TBCR1	W	TBC15	TBC14	TBC13	TBC12	TBC11	TBC10	TBC9	TBC8
07H	ISR	R/W	RST	RDC	CNT	OVW	TXE	RXE	PTX	PRX
08H	CRDA0	R	A7	A6	A5	A4	A3	A2	A1	A0
	RSAR0	W	A7	A6	A5	A4	A3	A2	A1	A0
09H	CRDA1	R	A15	A14	A13	A12	A11	A10	A9	A8
	RSAR1	W	A15	A14	A13	A12	A11	A10	A9	A8
0AH	8019ID0	R	0	1	0	1	0	0	0	0
	RBCR0	W	RBC7	RBC6	RBC5	RBC4	RBC3	RBC2	RBC1	RBC0
0BH	8019ID1	R	0	1	1	1	0	0	0	0
	RBCR1	W	RBC15	RBC14	RBC13	RBC12	RBC11	RBC10	RBC9	RBC8
0CH	RSR	R	DFR	DIS	PHY	MPA	0	FAE	CRC	PRX
	RCR	W	-	-	MON	PRO	AM	AB	AR	SEP
0DH	CNTR0	R	CNT7	CNT6	CNT5	CNT4	CNT3	CNT2	CNT1	CNT0
	TCR	W	-	-	-	OFST	ATD	LB1	LB0	CRC
0EH	CNTR1	R	CNT7	CNT6	CNT5	CNT4	CNT3	CNT2	CNT1	CNT0
	DCR	W	-	FT1	FT0	ARM	LS	LAS	BOS	WTS
0FH	CNTR2	R	CNT7	CNT6	CNT5	CNT4	CNT3	CNT2	CNT1	CNT0
	IMR	W	-	RDCE	CNTE	OVWE	TXEE	RXEE	PTXE	PRXE

Page 1 (PS1=0, PS0=1)

No.	Name	Type	Bit 7	Bit 6	Bit 5	Bit 4	Bit 3	Bit 2	Bit 1	Bit 0
00H	CR	R/W	PS1	PS0	RD2	RD1	RD0	TXP	STA	STP
01H	PAR0	R/W	DA7	DA6	DA5	DA4	DA3	DA2	DA1	DA0
02H	PAR1	R/W	DA15	DA14	DA13	DA12	DA11	DA10	DA9	DA8
03H	PAR2	R/W	DA23	DA22	DA21	DA20	DA19	DA18	DA17	DA16
04H	PAR3	R/W	DA31	DA30	DA29	DA28	DA27	DA26	DA25	DA24
05H	PAR4	R/W	DA39	DA38	DA37	DA36	DA35	DA34	DA33	DA32
06H	PAR5	R/W	DA47	DA46	DA45	DA44	DA43	DA42	DA41	DA40
07H	CURR	R/W	A15	A14	A13	A12	A11	A10	A9	A8
08H	MAR0	R/W	FB7	FB6	FB5	FB4	FB3	FB2	FB1	FB0
09H	MAR1	R/W	FB15	FB14	FB13	FB12	FB11	FB10	FB9	FB8
0AH	MAR2	R/W	FB23	FB22	FB21	FB20	FB19	FB18	FB17	FB16
0BH	MAR3	R/W	FB31	FB30	FB29	FB28	FB27	FB26	FB25	FB24
0CH	MAR4	R/W	FB39	FB38	FB37	FB36	FB35	FB34	FB33	FB32
0DH	MAR5	R/W	FB47	FB46	FB45	FB44	FB43	FB42	FB41	FB40
0EH	MAR6	R/W	FB55	FB54	FB53	FB52	FB51	FB50	FB49	FB48
0FH	MAR7	R/W	FB63	FB62	FB61	FB60	FB59	FB58	FB57	FB56

Page 2(PS1=1, PS0=0)

No.	Name	Type	Bit 7	Bit 6	Bit 5	Bit 4	Bit 3	Bit 2	Bit 1	Bit 0
00H	CR	R/W	PS1	PS0	RD2	RD1	RD0	TXP	STA	STP
01H	PSTART	R	A15	A14	A13	A12	A11	A10	A9	A8
02H	PSTOP	R	A15	A14	A13	A12	A11	A10	A9	A8
03H	-									
04H	TPSR	R	A15	A14	A13	A12	A11	A10	A9	A8
05H 0BH	-									
0CH	RCR	R	-	-	MON	PRO	AM	AB	AR	SEP
0DH	TCR	R	-	-	-	OFST	ATD	LB1	LB0	CRC
0EH	DCR	R	-	FT1	FT0	ARM	LS	LAS	BOS	WTS
0FH	IMR	R	-	RDCE	CNTE	OVWE	TXEE	RXEE	PTXE	PRXE

Page 3(PS1=1, PS0=1)

No.	Name	Type	Bit 7	Bit 6	Bit 5	Bit 4	Bit 3	Bit 2	Bit 1	Bit 0
00H	CR	R/W	PS1	PS0	RD2	RD1	RD0	TXP	STA	STP
01H	9346CR	R	EEM1	EEM0	-	-	EECS	EESK	EEDI	EEDO
		W	EEM1	EEM0	-	-	EECS	EESK	EEDI	-
02H	BPAGE	R/W	BP7	BP6	BP5	BP4	BP3	BP2	BP1	BP0
03H	CONFIG0	R	VerID1	VerID0	AUI	PNPJP	JP	BNC	0	0
04H	CONFIG1	R	IRQEN	IRQS2	IRQS1	IRQS0	IOS3	IOS2	IOS1	IOS0
		W*	IRQEN	-	-	-	-	-	-	-
05H	CONFIG2	R	PL1	PL0	BSELB	BS4	BS3	BS2	BS1	BS0
		W*	PL1	PL0	BSELB	-	-	-	-	-
06H	CONFIG3	R	PNP	FUDUP	LEDS1	LEDS0	-	SLEEP	PWRDN	ACTIVEB
		W*	-	-	-	-	-	SLEEP	PWRDN	-
07H	TEST	R/W	Reserved, Do not write							
08H	CSNSAV	R	CSN7	CSN6	CSN5	CSN4	CSN3	CSN2	CSN1	CNS0
09H	HLTCLK	W	HLT7	HLT6	HLT5	HLT4	HLT3	HLT2	HLT1	HLT0
0AH	-	-	Reserved							
0BH	INTR	R	INT7	INT6	INT5	INT4	INT3	INT2	INT1	INT0
0CH	FMWP	W*	Flash Memory Write Protect							
0DH	CONFIG4	R	-	-	-	-	-	-	-	IOMS
0EH 0FH	-	-	Reserved							

Note: The registers marked with type='W*' can be written only if bits EEM1=EEM0=1.

5.1.2. Register Functions
5.1.2.1. NE2000 Compatible Registers

CR: Command Register (00H; Type=R/W)

This register is used to select register pages, enable or disable remote DMA operation and issue commands.

Bit	Symbol	Description																								
7, 6	PS1, PS0	<table border="1"> <thead> <tr> <th>PS1</th> <th>PS0</th> <th>Register Page</th> <th>Remark</th> </tr> </thead> <tbody> <tr> <td>0</td> <td>0</td> <td>0</td> <td>NE2000 compatible</td> </tr> <tr> <td>0</td> <td>1</td> <td>1</td> <td>NE2000 compatible</td> </tr> <tr> <td>1</td> <td>0</td> <td>2</td> <td>NE2000 compatible</td> </tr> <tr> <td>1</td> <td>1</td> <td>3</td> <td>RTL8019AS Configuration</td> </tr> </tbody> </table>	PS1	PS0	Register Page	Remark	0	0	0	NE2000 compatible	0	1	1	NE2000 compatible	1	0	2	NE2000 compatible	1	1	3	RTL8019AS Configuration				
PS1	PS0	Register Page	Remark																							
0	0	0	NE2000 compatible																							
0	1	1	NE2000 compatible																							
1	0	2	NE2000 compatible																							
1	1	3	RTL8019AS Configuration																							
5-3	RD2-0	<table border="1"> <thead> <tr> <th>RD2</th> <th>RD1</th> <th>RD0</th> <th>Function</th> </tr> </thead> <tbody> <tr> <td>0</td> <td>0</td> <td>0</td> <td>Not allowed</td> </tr> <tr> <td>0</td> <td>0</td> <td>1</td> <td>Remote Read</td> </tr> <tr> <td>0</td> <td>1</td> <td>0</td> <td>Remote Write</td> </tr> <tr> <td>0</td> <td>1</td> <td>1</td> <td>Send Packet</td> </tr> <tr> <td>1</td> <td>*</td> <td>*</td> <td>Abort/Complete remote DMA</td> </tr> </tbody> </table>	RD2	RD1	RD0	Function	0	0	0	Not allowed	0	0	1	Remote Read	0	1	0	Remote Write	0	1	1	Send Packet	1	*	*	Abort/Complete remote DMA
RD2	RD1	RD0	Function																							
0	0	0	Not allowed																							
0	0	1	Remote Read																							
0	1	0	Remote Write																							
0	1	1	Send Packet																							
1	*	*	Abort/Complete remote DMA																							
2	TXP	This bit must be set to transmit a packet. It is internally reset either after the transmission is completed or aborted. Writing a 0 has no effect.																								
1	STA	The STA bit controls nothing. It only reflects the value written to this bit. POWER UP=0.																								
0	STP	This bit is the STOP command. When it is set, no packets will be received or transmitted. POWER UP=1. <table border="1"> <thead> <tr> <th>STA</th> <th>STP</th> <th>Function</th> </tr> </thead> <tbody> <tr> <td>1</td> <td>0</td> <td>Start Command</td> </tr> <tr> <td>0</td> <td>1</td> <td>Stop Command</td> </tr> </tbody> </table>	STA	STP	Function	1	0	Start Command	0	1	Stop Command															
STA	STP	Function																								
1	0	Start Command																								
0	1	Stop Command																								

ISR: Interrupt Status Register (07H; Type=R/W in Page0)

This register reflects the NIC status. The host reads it to determine the cause of an interrupt. Individual bits are cleared by writing a "1" into the corresponding bit. It must be cleared after power up.

Bit	Symbol	Description
7	RST	This bit is set when NIC enters reset state and is cleared when a start command is issued to the CR. It is also set when receive buffer overflows and is cleared when one or more packets have been read from the buffer.
6	RDC	Set when remote DMA operation has been completed.
5	CNT	Set when MSB of one or more of the network tally counters has been set.
4	OVW	This bit is set when the receive buffer has been exhausted.
3	TXE	Transmit error bit is set when a packet transmission is aborted due to excessive collisions.
2	RXE	This bit is set when a packet received with one or more of the following errors: - CRC error - Frame alignment error -Missed packet
1	PTX	This bit indicates packet transmitted with no errors.
0	PRX	This bit indicates packet received with no errors.

IMR: Interrupt Mask Register (0FH; Type=W in Page0, Type=R in Page2)

All bits correspond to the bits in the ISR register. POWER UP=all 0s. Setting individual bits will enable the corresponding interrupts.

DCR: Data Configuration Register (0EH; Type=W in Page0, Type=R in Page2)

Bit	Symbol	Description
7	-	Always 1
6, 5	FT1, FT0	FIFO threshold select bit 1 and 0.
4	ARM	Auto-initialize Remote 0: Send Packet Command not executed. 1: Send Packet Command executed.
3	LS	Loopback Select 0: Loopback mode selected. Bits 1 and 2 of the TCR must also be programmed for Loopback operation. 1: Normal Operation
2	LAS	This bit must be set to zero. NIC only supports dual 16-bit DMA mode. POWER UP =1
1	BOS	Byte Order Select (Not implement) 0: MS byte placed on MD15-8 and LS byte on MD7-0. (32xxx,80x86) 1: MS byte placed on MD7-0 and LS byte on MD15-8. (680x0)
0	WTS	Word Transfer Select 0: byte-wide DMA transfer 1: word-wide DMA transfer

TCR: Transmit Configuration Register (0DH; Type=W in Page0, Type=R in Page2)

Bit	Symbol	Description																								
7	-	Always 1																								
6	-	Always 1																								
5	-	Always 1																								
4	OFST	Collision Offset Enable.																								
3	ATD	Auto Transmit Disable. 0: normal operation 1: reception of multicast address hashing to bit 62 disables transmitter, reception of multicast address hashing to bit 63 enables transmitter.																								
2, 1	LB1, LB0	<table border="1"> <thead> <tr> <th>LB1</th> <th>LB0</th> <th>Mode</th> <th>Remark</th> </tr> </thead> <tbody> <tr> <td>0</td> <td>0</td> <td>0</td> <td>Normal Operation</td> </tr> <tr> <td>0</td> <td>1</td> <td>1</td> <td>Internal Lookback</td> </tr> <tr> <td>1</td> <td>0</td> <td>2</td> <td>External Lookback</td> </tr> <tr> <td>1</td> <td>1</td> <td>3</td> <td>External Lookback</td> </tr> </tbody> </table>	LB1	LB0	Mode	Remark	0	0	0	Normal Operation	0	1	1	Internal Lookback	1	0	2	External Lookback	1	1	3	External Lookback				
LB1	LB0	Mode	Remark																							
0	0	0	Normal Operation																							
0	1	1	Internal Lookback																							
1	0	2	External Lookback																							
1	1	3	External Lookback																							
0	CRC	<p>The NIC CRC logic comprises a CRC generator for transmitter and a CRC checker for receiver. This bit controls the activity of the CRC logic. If this bit set, CRC is inhibited by transmitter. Otherwise CRC is appended by transmitter.</p> <table border="1"> <thead> <tr> <th colspan="2">Conditions</th> <th colspan="2">CRC Logic Activities</th> </tr> <tr> <th>CRC Bit</th> <th>Mode</th> <th>CRC Generator</th> <th>CRC Checker</th> </tr> </thead> <tbody> <tr> <td>0</td> <td>normal</td> <td>enabled</td> <td>enabled</td> </tr> <tr> <td>1</td> <td>normal</td> <td>disabled</td> <td>enabled</td> </tr> <tr> <td>0</td> <td>loopback</td> <td>enabled</td> <td>disabled</td> </tr> <tr> <td>1</td> <td>loopback</td> <td>disabled</td> <td>enabled</td> </tr> </tbody> </table>	Conditions		CRC Logic Activities		CRC Bit	Mode	CRC Generator	CRC Checker	0	normal	enabled	enabled	1	normal	disabled	enabled	0	loopback	enabled	disabled	1	loopback	disabled	enabled
Conditions		CRC Logic Activities																								
CRC Bit	Mode	CRC Generator	CRC Checker																							
0	normal	enabled	enabled																							
1	normal	disabled	enabled																							
0	loopback	enabled	disabled																							
1	loopback	disabled	enabled																							

TSR: Transmit Status Register (04H; Type=R in Page0)

This register indicates the status of a packet transmission.

Bit	Symbol	Description
7	OWC	Out of Window Collision. It is set when a collision is detected after a slot time (51.2us). Transmissions are rescheduled as in normal collisions.
6	CDH	CD Heartbeat. The NIC watches for a collision signal (i.e. CD Heartbeat signal) during the first 6.4us of the interframe gap following a transmission. This bit is set if the transceiver fails to send this signal.
5	-	Always 1.
4	CRS	Carrier Sense lost bit is set when the carrier is lost during transmitting a packet.
3	ABT	It indicates the NIC aborted the transmission because of excessive collisions.
2	COL	It indicates the transmission collided with some other station on the network.
1	-	Always 1
0	PTX	This bit indicates the transmission completes with no errors.

RCR: Receive Configuration Register (0CH; Type=W in Page0, Type=R in Page2)

Bit	Symbol	Description
7	-	Always 1
6	-	Always 1
5	MON	When monitor mode bit is set, received packets are checked for address match, good CRC and frame alignment but not buffered to memory. Otherwise, packets will be buffered to memory.
4	PRO	If PRO=1, all packets with physical destination address accepted. If PRO=0, physical destination address must match the node address programmed in PAR0-5.
3	AM	If AM=1, packets with multicast destination address are accepted. If AM=0, packets with multicast destination address are rejected.
2	AB	If AB=1, packets with broadcast destination address are accepted. If AB=0, packets with broadcast destination address are rejected.
1	AR	If AR=1, packets with length fewer than 64 bytes are accepted. If AR=0, packets with length fewer than 64 bytes are rejected.
0	SEP	If SEP=1, packets with receive errors are accepted. If SEP=0, packets with receive errors are rejected.

RSR: Receive Status Register (0CH; Type=R in Page0)

Bit	Symbol	Description
7	DFR	Deffering. Set when a carrier or a collision is detected.
6	DIS	Receiver Disabled. When the NIC enters the monitor mode, this bit is set and receiver is disabled. Reset when receiver is enabled after leaving the monitor mode.
5	PHY	PHY bit is set when the received packet has a multicast or broadcast destination address. It is reset when the received packet has a physical destination address.
4	MPA	Missed Packet bit is set when the incoming packet can not be accepted by NIC because of a lack of receive buffer or if NIC is in monitor mode. Increment CNTR2 tally counter.
3	-	Always 1.
2	FAE	Frame Alignment Error bit reflects the incoming packet didn't end on a byte boundary and CRC did not match at last byte boundary. Increment CNTR0 tally counter.
1	CRC	CRC error bit reflects packet received with CRC error. This bit will also be set for FAE errors. Increment CNTR1 tally counter.
0	PRX	This bit indicates packet received with no errors.

CLDA0, 1: Current Local DMA Registers (01H & 02H; Type=R in Page0)

These two registers can be read to get the current local DMA address.

- PSTART:** Page Start Register (01H; Type=W in Page0, Type=R in Page 2)
The Page Start register sets the start page address of the receive buffer ring.
- PSTOP:** Page Stop Register (02H; Type=W in Page0, Type=R in Page2)
The Page Stop register sets the stop page address of the receive buffer ring. In 8 bit mode the PSTOP register should not exceed to 0x60, in 16 bit mode the PSTOP register should not exceed to 0x80.
- BNRY:** Boundary Register (03H; Type=R/W in Page0)
This register is used to prevent overwrite of the receive buffer ring. It is typically used as a pointer indicating the last receive buffer page the host has read.
- TPSR:** Transmit Page Start Register (04H; Type=W in Page0)
This register sets the start page address of the packet to the transmitted.
- TBCR0,1:** Transmit Byte Count Registers (05H & 06H; Type=W in Page0)
These two registers set the byte counts of the packet to be transmitted.
- NCR:** Number of Collisions Register (05H; Type=R in Page0)
The register records the number of collisions a node experiences during a packet transmission.
- FIFO:** First In First Out Register (06H; Type=R in Page0)
This register allows the host to examine the contents of the FIFO after loopback.
- CRDA0, 1:** Current Remote DMA Address registers (08H & 09H; Type=R in Page0)
These two registers contain the current address of remote DMA.
- RSAR0,1:** Remote Start Address Registers (08H & 09H; Type=W in Page0)
These two registers set the start address of remote DMA.
- RBCR0,1:** Remote Byte Count Registers (0AH & 0BH; Type=W in Page0)
These two registers se the data byte counts of remote DMA.
- CNTR0:** Frame Alignment Error Tally Counter Register (0DH; Type=R in Page0)
- CNTR1:** CRC Error Tally Counter Register (0EH; Type=R in Page0)
- CNTR2:** Missed Packet Tally Counter Register (0FH; Type=R in Page0)
- PAR0-5:** Physical Address Registers (01H - 06H; Type=R/W in Page1)
These registers contain my Ethernet node address and are used to compare the destination adderss of incoming packets for acceptance or rejection.
- CURR:** Current Page Register (07H; Type=R/W in Page1)
This register points to the page address of the first receive buffer page to be used for a packet reception.

MAR0-7: Multicast Address Register (08H - 0FH; Type=R/W in Page1)
 These registers provide filtering bits of multicast addresses hashed by the CRC logic.

5.1.2.2. RTL8019AS Defined Registers

Page 0 (PS1=0, PS0=0)

Two registers are defined to contain the RTL8019AS chip ID.

No.	Name	Type	Bit7-0
0AH	8019ID0	R	50H (ASCII code of "P")
0BH	8019ID1	R	70H (ASCII code of "p")

Page 3(PS1=1, PS0=1)

Page3 Power Up Values before loading jumper states and 9346 contents

No.	Name	Type	Bit 7	Bit 6	Bit 5	Bit 4	Bit 3	Bit 2	Bit 1	Bit 0
00H	CR	R/W	0	0	1	0	0	0	0	1
01H	9346CR	R/W	0	0	-	-	*	*	*	*
02H	BPAGE	R/W	0	0	0	0	0	0	0	0
03H	CONFIG0	R/W	0	0	*	*	*	*	0	0
04H	CONFIG1	R/W	1	*	*	*	*	*	*	*
05H	CONFIG2	R/W	*	*	0	*	*	*	*	*
06H	CONFIG3	R/W	*	*	*	*	*	0	0	1
07H	TEST	R/W	-	-	-	-	-	-	-	-
08H	CSNSAV	R	0	0	0	0	0	0	0	0
09H	HLTCLK	W	1	1	1	1	1	1	1	1
0AH	-									
0BH	INTR	R	*	*	*	*	*	*	*	*
0CH	FMWP	W								
0DH	CONFIG4	R	-	-	-	-	-	-	-	*
0EH	-									
0FH										

Page3 Content Descriptions

9346CR: 9346 Command Register (01H; Type=R/W except Bit0=R)

Bit	Symbol	Description															
7-6	EEM1-0	These 2 bits select the RTL8019AS operating mode. <table border="1" data-bbox="553 415 1284 1087" style="margin-left: 20px;"> <thead> <tr> <th>EEM1</th> <th>EEM0</th> <th>Operating Mode</th> </tr> </thead> <tbody> <tr> <td>0</td> <td>0</td> <td>Normal (DP8390 compatible)</td> </tr> <tr> <td>0</td> <td>1</td> <td>Auto-load: Entering this mode will make the RTL8019AS load the contents of 9346 like when the RSTDRV signal is asserted. This auto-load operation will take about 2ms. After it is completed, the RTL8019AS goes back to the normal mode automatically (EEM1=EEM0 =0) and the CR register is reset to 21H.</td> </tr> <tr> <td>1</td> <td>0</td> <td>9346 programming: In this mode, both the local & remote DMA operation of 8390 are disabled. The 9346 can be directly accessed via bit3-0 which now reflect the states of EECS, EESK, EEDI, & EEDO pins respectively.</td> </tr> <tr> <td>1</td> <td>1</td> <td>Config register write enable: Before writing to the Page3 CONFIG1-3 registers, the RTL8019AS must be placed in this mode. This will prevent RTL8019AS's configurations from accidental change.</td> </tr> </tbody> </table>	EEM1	EEM0	Operating Mode	0	0	Normal (DP8390 compatible)	0	1	Auto-load: Entering this mode will make the RTL8019AS load the contents of 9346 like when the RSTDRV signal is asserted. This auto-load operation will take about 2ms. After it is completed, the RTL8019AS goes back to the normal mode automatically (EEM1=EEM0 =0) and the CR register is reset to 21H.	1	0	9346 programming: In this mode, both the local & remote DMA operation of 8390 are disabled. The 9346 can be directly accessed via bit3-0 which now reflect the states of EECS, EESK, EEDI, & EEDO pins respectively.	1	1	Config register write enable: Before writing to the Page3 CONFIG1-3 registers, the RTL8019AS must be placed in this mode. This will prevent RTL8019AS's configurations from accidental change.
EEM1	EEM0	Operating Mode															
0	0	Normal (DP8390 compatible)															
0	1	Auto-load: Entering this mode will make the RTL8019AS load the contents of 9346 like when the RSTDRV signal is asserted. This auto-load operation will take about 2ms. After it is completed, the RTL8019AS goes back to the normal mode automatically (EEM1=EEM0 =0) and the CR register is reset to 21H.															
1	0	9346 programming: In this mode, both the local & remote DMA operation of 8390 are disabled. The 9346 can be directly accessed via bit3-0 which now reflect the states of EECS, EESK, EEDI, & EEDO pins respectively.															
1	1	Config register write enable: Before writing to the Page3 CONFIG1-3 registers, the RTL8019AS must be placed in this mode. This will prevent RTL8019AS's configurations from accidental change.															
5-4	-	Not used.															
3	EECS	These bits reflect the state of EECS, EESK, EEDI & EEDO pins in auto-load or 9346 programming mode.															
2	EESK																
1	EEDI																
0	EEDO																

BPAGE: BROM Page Register (02H; Type=R/W)

This register selects a BROM page to be read by the host. Totally it can select 256 pages with 16k bytes per page. Thus the maximum BROM size is 256*16k=4M bytes.

CONFIG0: RTL8019AS Configuration Register 0 (03H; Type=R except Bit[7:6]=R/W)

Bit	Symbol	Description																
7-6	VERID	Version ID: These two bits are defined as below. <table border="1" style="margin-left: 20px;"> <thead> <tr> <th>Bit7</th> <th>Bit6</th> <th>Type</th> <th>Mode</th> </tr> </thead> <tbody> <tr> <td>1</td> <td>1</td> <td>R</td> <td>RTL8019</td> </tr> <tr> <td>0</td> <td>0</td> <td>R</td> <td>RTL8019A</td> </tr> <tr> <td>0</td> <td>0</td> <td>R/W</td> <td>RTL8019AS, these two bits are all "0" when power on, but can be written in RTL8019AS's config write enable mode (EEM0=EEM1=1). Software uses these differences to identify the chip.</td> </tr> </tbody> </table>	Bit7	Bit6	Type	Mode	1	1	R	RTL8019	0	0	R	RTL8019A	0	0	R/W	RTL8019AS , these two bits are all "0" when power on, but can be written in RTL8019AS's config write enable mode (EEM0=EEM1=1). Software uses these differences to identify the chip.
Bit7	Bit6	Type	Mode															
1	1	R	RTL8019															
0	0	R	RTL8019A															
0	0	R/W	RTL8019AS , these two bits are all "0" when power on, but can be written in RTL8019AS's config write enable mode (EEM0=EEM1=1). Software uses these differences to identify the chip.															
5	AUI	This bit is set when external MAU is used on AUI interface. Therefore it is set when in 10Base5 mode or the AUI input pin is high.																
4	PNPJP	This bit is set when PNP jumper pin is pulled high externally.																
3	JP	This bit reflects the state of JP input. It, when set, indicates the RTL8019 is in jumper mode.																
2	BNC	When set, this bit indicates that the RTL8019 is using the 10Base2 thin cable as its networking medium. This bit will be set in the following 2 cases: (1) PL1=PL0=0 (auto-detect) and link test fails (2) PL1=PL0=1 (10 Base 2)																
1-0	0	Always 0s.																

The following table describes the behavior of bits and pins for cabling media.

Media Type	AUI Input	Selected Media	AUI Bit	BNC Bit	LEDBNC Output	Original BNC bit in 8019 (For reference only)
10Base5	x	AUI	1	0	L	0
10Base2	x	BNC	0	1	H	1
10BaseT	x	UTP	0	0	L	0
Link disabled						
Auto detect Link OK	x	UTP	0	0	L	0
Auto detect Link fail	L	BNC	0	1	H	1
Auto detect Link fail	H	AUI	1	0	L	1

CONFIG1: RTL8019AS Configuration Register 1 (04H; Type=R except Bit7=R/W)

Bit	Symbol	Description																																																																																					
7	IRQEN	<p>IRQ Enable:</p> <p>This bit controls the state of the interrupt request line selected by IRQS2-0. If this bit is set, the interrupt line goes high upon an interrupt request and will be low when there is no interrupt request.</p> <p>The interrupt line will be forced to tri-state if this bit is reset.</p> <p>This bit's power-up initial value is 1 and may be modified by software if EEM1=EEM0=1 in 9346CR register.</p>																																																																																					
6-4	IRQS2-0	<p>IRQ Select :</p> <p>These 3 bits select one of INT7-0 to reflect the RTL8019AS's interrupt request status. All unselected interrupt lines will be tri-stated.</p> <table border="1" data-bbox="548 642 1289 932"> <thead> <tr> <th>IRQS2</th> <th>IRQS1</th> <th>IRQS0</th> <th>Interrupt Line</th> <th>Assigned ISA IRQ</th> </tr> </thead> <tbody> <tr><td>0</td><td>0</td><td>0</td><td>INT0</td><td>IRQ2/9</td></tr> <tr><td>0</td><td>0</td><td>1</td><td>INT1</td><td>IRQ3</td></tr> <tr><td>0</td><td>1</td><td>0</td><td>INT2</td><td>IRQ4</td></tr> <tr><td>0</td><td>1</td><td>1</td><td>INT3</td><td>IRQ5</td></tr> <tr><td>1</td><td>0</td><td>0</td><td>INT4</td><td>IRQ10</td></tr> <tr><td>1</td><td>0</td><td>1</td><td>INT5</td><td>IRQ11</td></tr> <tr><td>1</td><td>1</td><td>0</td><td>INT6</td><td>IRQ12</td></tr> <tr><td>1</td><td>1</td><td>1</td><td>INT7</td><td>IRQ15</td></tr> </tbody> </table>	IRQS2	IRQS1	IRQS0	Interrupt Line	Assigned ISA IRQ	0	0	0	INT0	IRQ2/9	0	0	1	INT1	IRQ3	0	1	0	INT2	IRQ4	0	1	1	INT3	IRQ5	1	0	0	INT4	IRQ10	1	0	1	INT5	IRQ11	1	1	0	INT6	IRQ12	1	1	1	INT7	IRQ15																																								
IRQS2	IRQS1	IRQS0	Interrupt Line	Assigned ISA IRQ																																																																																			
0	0	0	INT0	IRQ2/9																																																																																			
0	0	1	INT1	IRQ3																																																																																			
0	1	0	INT2	IRQ4																																																																																			
0	1	1	INT3	IRQ5																																																																																			
1	0	0	INT4	IRQ10																																																																																			
1	0	1	INT5	IRQ11																																																																																			
1	1	0	INT6	IRQ12																																																																																			
1	1	1	INT7	IRQ15																																																																																			
3-0	IOS3-0	<p>Select I/O base address.</p> <table border="1" data-bbox="561 1024 1198 1566"> <thead> <tr> <th>IOS3</th> <th>IOS2</th> <th>IOS1</th> <th>IOS0</th> <th>I/O Base</th> </tr> </thead> <tbody> <tr><td>0</td><td>0</td><td>0</td><td>0</td><td>300H</td></tr> <tr><td>0</td><td>0</td><td>0</td><td>1</td><td>320H</td></tr> <tr><td>0</td><td>0</td><td>1</td><td>0</td><td>340H</td></tr> <tr><td>0</td><td>0</td><td>1</td><td>1</td><td>360H</td></tr> <tr><td>1</td><td>0</td><td>0</td><td>0</td><td>380H</td></tr> <tr><td>1</td><td>0</td><td>0</td><td>1</td><td>3A0H</td></tr> <tr><td>1</td><td>0</td><td>1</td><td>0</td><td>3C0H</td></tr> <tr><td>1</td><td>0</td><td>1</td><td>1</td><td>3E0H</td></tr> <tr><td>0</td><td>1</td><td>0</td><td>0</td><td>200H</td></tr> <tr><td>0</td><td>1</td><td>0</td><td>1</td><td>220H</td></tr> <tr><td>0</td><td>1</td><td>1</td><td>0</td><td>240H</td></tr> <tr><td>0</td><td>1</td><td>1</td><td>1</td><td>260H</td></tr> <tr><td>1</td><td>1</td><td>0</td><td>0</td><td>280H</td></tr> <tr><td>1</td><td>1</td><td>0</td><td>1</td><td>2A0H</td></tr> <tr><td>1</td><td>1</td><td>1</td><td>0</td><td>2C0H</td></tr> <tr><td>1</td><td>1</td><td>1</td><td>1</td><td>2E0H</td></tr> </tbody> </table>	IOS3	IOS2	IOS1	IOS0	I/O Base	0	0	0	0	300H	0	0	0	1	320H	0	0	1	0	340H	0	0	1	1	360H	1	0	0	0	380H	1	0	0	1	3A0H	1	0	1	0	3C0H	1	0	1	1	3E0H	0	1	0	0	200H	0	1	0	1	220H	0	1	1	0	240H	0	1	1	1	260H	1	1	0	0	280H	1	1	0	1	2A0H	1	1	1	0	2C0H	1	1	1	1	2E0H
IOS3	IOS2	IOS1	IOS0	I/O Base																																																																																			
0	0	0	0	300H																																																																																			
0	0	0	1	320H																																																																																			
0	0	1	0	340H																																																																																			
0	0	1	1	360H																																																																																			
1	0	0	0	380H																																																																																			
1	0	0	1	3A0H																																																																																			
1	0	1	0	3C0H																																																																																			
1	0	1	1	3E0H																																																																																			
0	1	0	0	200H																																																																																			
0	1	0	1	220H																																																																																			
0	1	1	0	240H																																																																																			
0	1	1	1	260H																																																																																			
1	1	0	0	280H																																																																																			
1	1	0	1	2A0H																																																																																			
1	1	1	0	2C0H																																																																																			
1	1	1	1	2E0H																																																																																			

CONFIG2: RTL8019AS Configuration Register 2 (05H; Type=R except Bit[7:5]=R/W)

Bit	Symbol	Description																																																																																																																																																
7-6	PL1-0	Select network medium types. <table border="1" style="margin-left: 20px;"> <thead> <tr> <th>PL1</th> <th>PL0</th> <th>Medium Type</th> </tr> </thead> <tbody> <tr> <td>0</td> <td>0</td> <td>TP/CX auto-detect (10BaseT link test is enabled)</td> </tr> <tr> <td>0</td> <td>1</td> <td>10BaseT with link test disabled</td> </tr> <tr> <td>1</td> <td>0</td> <td>10Base5</td> </tr> <tr> <td>1</td> <td>1</td> <td>10Base2</td> </tr> </tbody> </table>	PL1	PL0	Medium Type	0	0	TP/CX auto-detect (10BaseT link test is enabled)	0	1	10BaseT with link test disabled	1	0	10Base5	1	1	10Base2																																																																																																																																	
PL1	PL0	Medium Type																																																																																																																																																
0	0	TP/CX auto-detect (10BaseT link test is enabled)																																																																																																																																																
0	1	10BaseT with link test disabled																																																																																																																																																
1	0	10Base5																																																																																																																																																
1	1	10Base2																																																																																																																																																
5	BSELB	This bit, when set, forces the BROM disabled regardless of the contents of BS4-0. Its power-up initial value is 0 and can be modified by software if EEM1=EEM0=1 in 9346CR register.																																																																																																																																																
4-0	BS4-0	These bits select the BROM size & memory base address. <table border="1" style="margin-left: 20px;"> <thead> <tr> <th>BS4</th> <th>BS3</th> <th>BS2</th> <th>BS1</th> <th>BS0</th> <th>BROM Base & size</th> </tr> </thead> <tbody> <tr> <td>0</td> <td>0</td> <td>*</td> <td>*</td> <td>*</td> <td>Disabled</td> </tr> <tr> <td>0</td> <td>1</td> <td>0</td> <td>0</td> <td>0</td> <td>C000h, 32K</td> </tr> <tr> <td>0</td> <td>1</td> <td>0</td> <td>0</td> <td>1</td> <td>C800h, 32K</td> </tr> <tr> <td>0</td> <td>1</td> <td>0</td> <td>1</td> <td>0</td> <td>D000h, 32K</td> </tr> <tr> <td>0</td> <td>1</td> <td>0</td> <td>1</td> <td>1</td> <td>D800h, 32K</td> </tr> <tr> <td>0</td> <td>1</td> <td>1</td> <td>0</td> <td>0</td> <td>C000h, 64K</td> </tr> <tr> <td>0</td> <td>1</td> <td>1</td> <td>0</td> <td>1</td> <td>D000h, 64K</td> </tr> <tr> <td>1</td> <td>0</td> <td>0</td> <td>0</td> <td>0</td> <td>C000h, 16K</td> </tr> <tr> <td>1</td> <td>0</td> <td>0</td> <td>0</td> <td>1</td> <td>C400h, 16K</td> </tr> <tr> <td>1</td> <td>0</td> <td>0</td> <td>1</td> <td>0</td> <td>C800h, 16K</td> </tr> <tr> <td>1</td> <td>0</td> <td>0</td> <td>1</td> <td>1</td> <td>CC00h, 16K</td> </tr> <tr> <td>1</td> <td>0</td> <td>1</td> <td>0</td> <td>0</td> <td>D000h, 16K</td> </tr> <tr> <td>1</td> <td>0</td> <td>1</td> <td>0</td> <td>1</td> <td>D400h, 16K</td> </tr> <tr> <td>1</td> <td>0</td> <td>1</td> <td>1</td> <td>0</td> <td>D800h, 16K</td> </tr> <tr> <td>1</td> <td>0</td> <td>1</td> <td>1</td> <td>1</td> <td>DC00h, 16K</td> </tr> <tr> <td>1</td> <td>1</td> <td>0</td> <td>0</td> <td>0</td> <td>C000h, Page</td> </tr> <tr> <td>1</td> <td>1</td> <td>0</td> <td>0</td> <td>1</td> <td>C400h, Page</td> </tr> <tr> <td>1</td> <td>1</td> <td>0</td> <td>1</td> <td>0</td> <td>C800h, Page</td> </tr> <tr> <td>1</td> <td>1</td> <td>0</td> <td>1</td> <td>1</td> <td>CC00h, Page</td> </tr> <tr> <td>1</td> <td>1</td> <td>1</td> <td>0</td> <td>0</td> <td>D000h, Page</td> </tr> <tr> <td>1</td> <td>1</td> <td>1</td> <td>0</td> <td>1</td> <td>D400h, Page</td> </tr> <tr> <td>1</td> <td>1</td> <td>1</td> <td>1</td> <td>0</td> <td>D800h, Page</td> </tr> <tr> <td>1</td> <td>1</td> <td>1</td> <td>1</td> <td>1</td> <td>DC00h, Page</td> </tr> </tbody> </table> <p>The RTL8019AS supports a special BROM mode: page mode. In page mode, the BROM always occupies 16K-byte host memory space. However the actual BROM size can be up to 4M bytes.</p> <p>The BROM is divided into several 16K-byte pages. The power on boot page is set to page 0 and the program in page 0 is responsible to select the other pages by the BPAGE register and load their programs.</p> <p>In page mode, bits BP7-0 of BPAGE register are mapped to the BA21-14 pins to select the proper BROM page. In other modes, BA21-16 are not used and the BA15-14 outputs are shown in the following table.</p>	BS4	BS3	BS2	BS1	BS0	BROM Base & size	0	0	*	*	*	Disabled	0	1	0	0	0	C000h, 32K	0	1	0	0	1	C800h, 32K	0	1	0	1	0	D000h, 32K	0	1	0	1	1	D800h, 32K	0	1	1	0	0	C000h, 64K	0	1	1	0	1	D000h, 64K	1	0	0	0	0	C000h, 16K	1	0	0	0	1	C400h, 16K	1	0	0	1	0	C800h, 16K	1	0	0	1	1	CC00h, 16K	1	0	1	0	0	D000h, 16K	1	0	1	0	1	D400h, 16K	1	0	1	1	0	D800h, 16K	1	0	1	1	1	DC00h, 16K	1	1	0	0	0	C000h, Page	1	1	0	0	1	C400h, Page	1	1	0	1	0	C800h, Page	1	1	0	1	1	CC00h, Page	1	1	1	0	0	D000h, Page	1	1	1	0	1	D400h, Page	1	1	1	1	0	D800h, Page	1	1	1	1	1	DC00h, Page
BS4	BS3	BS2	BS1	BS0	BROM Base & size																																																																																																																																													
0	0	*	*	*	Disabled																																																																																																																																													
0	1	0	0	0	C000h, 32K																																																																																																																																													
0	1	0	0	1	C800h, 32K																																																																																																																																													
0	1	0	1	0	D000h, 32K																																																																																																																																													
0	1	0	1	1	D800h, 32K																																																																																																																																													
0	1	1	0	0	C000h, 64K																																																																																																																																													
0	1	1	0	1	D000h, 64K																																																																																																																																													
1	0	0	0	0	C000h, 16K																																																																																																																																													
1	0	0	0	1	C400h, 16K																																																																																																																																													
1	0	0	1	0	C800h, 16K																																																																																																																																													
1	0	0	1	1	CC00h, 16K																																																																																																																																													
1	0	1	0	0	D000h, 16K																																																																																																																																													
1	0	1	0	1	D400h, 16K																																																																																																																																													
1	0	1	1	0	D800h, 16K																																																																																																																																													
1	0	1	1	1	DC00h, 16K																																																																																																																																													
1	1	0	0	0	C000h, Page																																																																																																																																													
1	1	0	0	1	C400h, Page																																																																																																																																													
1	1	0	1	0	C800h, Page																																																																																																																																													
1	1	0	1	1	CC00h, Page																																																																																																																																													
1	1	1	0	0	D000h, Page																																																																																																																																													
1	1	1	0	1	D400h, Page																																																																																																																																													
1	1	1	1	0	D800h, Page																																																																																																																																													
1	1	1	1	1	DC00h, Page																																																																																																																																													

		<table border="1"> <thead> <tr> <th>BROM size</th> <th>BA14</th> <th>BA15</th> </tr> </thead> <tbody> <tr> <td>16K</td> <td>high</td> <td>high</td> </tr> <tr> <td>32K</td> <td>SA14</td> <td>high</td> </tr> <tr> <td>64K</td> <td>SA14</td> <td>SA15</td> </tr> </tbody> </table>	BROM size	BA14	BA15	16K	high	high	32K	SA14	high	64K	SA14	SA15
BROM size	BA14	BA15												
16K	high	high												
32K	SA14	high												
64K	SA14	SA15												

CONFIG3: RTL8019AS Configuration Register 3 (06H; Type=R except Bit[2:1]=R/W)

Bit	Symbol	Description															
7	PNP	This bit is negligible in jumper mode. In jumperless mode it, when set, indicates the RTL8019AS is operating in Plug and Play mode. This bit is set when the PNP pin is high or the PNP bit in 9346 is set in jumperless mode.															
6	FUDUP	When this bit is set, RTL8019AS is set to the full-duplex mode which enables simultaneously transmission and reception on the twisted-pair link to a full-duplex Ethernet switching hub. This feature not only increases the channel bandwidth from 10 to 20 Mbps but also avoids the performance degrading problem due to the channel contention characteristics of the Ethernet CSMA/CD protocol.															
5-4	LEDS1-0	<p>These two bits select the outputs to LED2-0 pins.</p> <table border="1"> <thead> <tr> <th>LEDS0</th> <th>LED0 Pin</th> </tr> </thead> <tbody> <tr> <td>0</td> <td>LED_COL</td> </tr> <tr> <td>1</td> <td>LED_LINK</td> </tr> </tbody> </table> <table border="1"> <thead> <tr> <th>LEDS1</th> <th>LED1 Pin</th> <th>LED2 Pin</th> </tr> </thead> <tbody> <tr> <td>0</td> <td>LED_RX</td> <td>LED_TX</td> </tr> <tr> <td>1</td> <td>LED_CRS</td> <td>MCSB</td> </tr> </tbody> </table> <p>Please refer to section 6.5 for the behavior of LEDs. The MCSB signal is defined to put the local buffer SRAM into standby mode while DMA is not in progress and thus save powers.</p>	LEDS0	LED0 Pin	0	LED_COL	1	LED_LINK	LEDS1	LED1 Pin	LED2 Pin	0	LED_RX	LED_TX	1	LED_CRS	MCSB
LEDS0	LED0 Pin																
0	LED_COL																
1	LED_LINK																
LEDS1	LED1 Pin	LED2 Pin															
0	LED_RX	LED_TX															
1	LED_CRS	MCSB															
3	-	Reserved. Must not write a 1 to this bit.															
2	SLEEP	<p>This bit, when set, puts RTL8019AS into sleep mode. In sleep mode, all LED signals (P.S. MCSB is not an LED signal) except LEDBNC are forced high to turn off the LEDs. The RTL8019AS still handles the network transmission and reception like in normal mode. The LEDBNC is not affected by this bit. This bit's power-up initial value is 0 and can be modified by software when EEM1=EEM0=1.</p>															
1	PWRDN	<p>This bit, when set, puts RTL8019AS into power down mode. RTL8019AS supports two kinds of power down modes, which is selected by the contents of the HLTCLK register: (1) mode 1: power down with clock running (2) mode 2: power down with clock halted In both power down modes, the RTL8019AS's serial network interface and transceiver are turned off. All network activities are ignored. All LED signals except LEDBNC are forced high. The LEDBNC is forced low to disable the DC convertor for coaxial transceiver. In power down mode2, the RTL8019AS stops its internal clock for minimal power consumption. Registers except HLTCLK are typically not accessible in this mode. This bit's initial value comes from 9346 and can be modified if EEM1=EEM0=1 in 9346CR register.</p>															

0	ACTIVEB	<p>This bit is the inverse of bit 0 in PnP Activate register (index 30H).</p> <p>When RTL8019AS is deactivated, all BROM memory read and I/O accesses to the Group1 registers except the HLTCLK register are ignored.</p> <p>The HLTCLK register and PnP logic work the same as when RTL8019AS is active.</p> <p>Note: The PnP logical device control register is the only way to activate RTL8019AS. Therefore, the HLTCLK register is allowed to be written to prevent RTL8019AS from dying when it is inactive in the clock-halted power-down mode.</p>
---	---------	--

CONFIG4 RTL8019AS Configuration Register 4 (0DH; Type=R)

Bit	Symbol	Description
7-1	-	Reserved
0	IOMS	When this bit is set, RTL8019AS uses SA15-SA0 to decode I/O address of NE2000 registers. When this bit is reset, RTL8019AS only decodes SA9-SA0 like the RTL8019 does. This mode is supported for applications which might require to fully decode I/O address. This bit is read-only and comes from the CONFIG4 byte(Offset 03H) of 9346(refer to section 6.3).

CSNSAV: CSN Save Register (08H; Type=R)

This register is provided to backup the CSN assigned to the PnP CSN register.

HLTCLK: Halt Clock Register (09H; Type=W)

This is the only active one of Group1 registers when RTL8019AS is inactivated.

Writing to this register is invalid if RTL8019AS is not in power down mode. (i.e. If PWRDN bit in CONFIG3 register is zero.)

The data written to this register determines the RTL8019AS's power down mode.

Data	Power Down Mode
52H (ASCII code of 'R')	Mode 1 - clock R unning
48H (ASCII code of 'H')	Mode 2 - clock H alted
Other values	Ignored

INTR: Interrupt Register (0BH; Type=R)

This register reflects the ISA bus states of INT7-0 pins.

FMWP: Flash Memory Write Protect Register (0Ch, Type=W)

This register is write only. A write to this register is valid only when EEM0=EEM1=1. Sequentially writing 2 bytes of data (57H then A8H) to this register enables the flash memory write operation. Writing other data to this register will reset the write sequence and disable the flash write. All flash memory write commands from host are ignored if the write operation is not enabled.

5.2. Group 2: Plug and Play (PnP) Registers

Auto-configuration Ports

Three 8-bit I/O ports are defined for the PnP read/write operations. They are called Auto-configuration ports and are listed below.

Port Name	Type	Location
ADDRESS	W	279H (Printer status port)
WRITE_DATA	W	A79H (Printer status port + 800H)
READ_DATA	R	Relocatable in range 200H to 3FFH

The Plug and Play registers are accessed by first writing the address of the desired register, which is called "**Register Index**" in the following paragraph, to the ADDRESS port, followed by a read of data from the READ_DATA port or a write of data to the WRITE_DATA port. A write to the ADDRESS port may be followed by any number of WRITE_DATA or READ_DATA accesses to the same indexed register without the need to write to the ADDRESS port before each access.

The Address port is also the write destination of the initiation key, which will be described later.

Plug and Play Registers

The Plug and Play registers may be divided into card registers and logical device registers. According to the Plug and Play specification, a PnP card may contain more than one logical devices. The card registers are unique for each card. However, the logical device registers are repeated for each logical device on the card. Furthermore, all card registers are card control registers, while the logical device registers can be divided into logical device control registers and configuration registers. Although an RTL8019AS card contains only one logical device, the following paragraph still depicts the Plug and Play registers by the same PnP categorizing method.

p.s. Those registers or bits not mentioned below are all read only with value=0.

5.2.1. Card Control Registers

Index	Name	Type	Definition
00H	Set RD_DATA port	W	The location of the READ_DATA port is determined by writing to this register. Bits[7:0] become ISA I/O read port address bits[9:2]. Address bits[1:0] of the READ_DATA port are always 1.
01H	Serial Isolation	R	A read to this register causes a PnP card in the <i>Isolation</i> state to compare one bit of the card's serial ID. This process will be described in more details in section 6.
02H	Config Control	W	<p>Bit[0] - Reset command Setting this bit will reset all logical devices and restore configuration registers to their power-up values. The CSN is preserved.</p> <p>Bit[1] - Wait for Key command Setting this bit makes the PnP card return to the <i>Wait for Key</i> state. The CSN is preserved.</p> <p>Bit[2] - PnP Reset CSN command Setting this bit will reset the card's CSN to 0. Both the CSN (index 06H) and CSNSAV (index F5H) registers are reset.</p> <p>Note that the hardware will automatically clear the bits and there is no need for software to clear them.</p>
03H	Wake[CSN]	W	A write to this register will cause all cards that have a CSN that matches the write data[7:0] to go from the <i>Sleep</i> state to either the <i>Isolation</i> state if the write data for this command is zero or the <i>Config</i> state if the write data is not zero.
04H	Resource Data	R	A read from this register reads the next byte of resource data. The Status register must be polled until bit[0] is set before this register may be read.
05H	Status	R	Bit[0] when set indicates it is okay to read the next data byte from the Resource Data register.
06H	Card Select Number (CSN)	R/W	A write to this register sets a card's CSN. The CSN is a value uniquely assigned to each ISA PnP card after the serial identification process so that each card may be individually selected during a Wake[CSN] command. The CSN value written to this register will also be recorded to the CSNSAV register located at PnP register index F5H and Group 1 Page3 offset 08H.
07H	Logical Device Number	R	00H (Only one logical device in RTL8019AS).

5.2.2. Logical Device Control Registers

Index	Name	Type	Definition
30H	Activate	R/W	For each logical device there is one Activate register that controls whether or not the logical device is active on the ISA bus. Bit[0], if set, activates the logical device. Before a logical device is activated, I/O range check must be disabled.
31H	I/O Range Check	R/W	This register is used to perform a conflict check on the I/O port range programmed for use by a logical device. Bit[1] - This bit, when set, enables I/O range check. I/O range check is only valid when the logical device is inactive. Bit[0] - If set, this bit forces the logical device to respond to I/O reads of the logical device's assigned I/O range with a 55H when I/O range check is in operation. If clear, the logical device drives AAH.

5.2.3. Logical Device Configuration Registers

Memory Configuration Registers

Index	Name	Type	Definition
40H	BROM base address bits[23:16]	R/W	Bits[23:20] & bit[17] are read only with values=0. All other bits are read/write bits.
41H	BROM base address bits[15:0]	R/W	Bits[13:8] are read only with values=0. All other bits are read/write bits.
42H	Memory Control	R	00H. (Only 8-bit operation is supported for BROM)

Note: The BROM size of RTL8019AS is determined by the 9346 contents but not the memory configuration registers.

I/O Configuration Registers

Index	Name	Type	Definition
60H	I/O base address bits[15:8]	R/W	Bits[15:10] are read only with values=0. All other bits are read/write bits.
61H	I/O base address bits[7:0]	R/W	Bits[4:0] are read only with values=0. All other bits are read/write bits.

Interrupt Configuration Registers

Index	Name	Type	Definition
70H	IRQ level	R/W	Read/write value indicating a selected interrupt level. Bits[3:0] select which ISA interrupt level is used. One selects IRQ1, fifteen selects IRQ15. IRQ0 is not a valid interrupt selection and represents no interrupt selection.

71H	IRQ type	R	Read/Write value indicating which type of interrupt is used for the IRQ selected above. Bit[1] - Level, 1=high, 0=low Bit[0] - Type, 1=level, 0=edge For RTL8019AS, this register is read only with value=02H.
-----	----------	---	---

DMA Configuration Registers

Index	Name	Type	Definition
74H	DMA channel select 0	R	04H (indicating no DMA channel is needed)
75H	DMA channel select 1	R	04H (indicating no DMA channel is needed)

Vendor Defined Registers

Index	Name	Type	Definition
F0H	CONFIG0	R	Direct mapping of the Page3 CONFIG0 register.
F1H	CONFIG1	R	Direct mapping of the Page3 CONFIG1 register.
F2H	CONFIG2	R	Direct mapping of the Page3 CONFIG2 register.
F3H	CONFIG3	R	Direct mapping of the Page3 CONFIG3 register.
F4H	-	-	
F5H	CSNSAV	R	Direct mapping of the Page3 CSNSAV register.
F6H	Vendor Control	W	Bit[2] - RT Reset CSN command Setting this bit will reset the card's CSN in the CSN register (index 06H) to 0. The CSNSAV register is not affected. This bit is cleared by hardware automatically.

6. Functional Descriptions

6.1. RTL8019AS Configuration Modes

The RTL8019AS supports 3 configuration modes: jumper, RT jumperless, and PnP.

JP Pin	PnP Pin	9346 Content		Mode	CONFIG0		CONFIG3	
		PNP	ACTIVEB		JP	PNPJP	PNP	ACTIVEB
H	H L	x	x	Jumper	1	1 0	0	0
L	H	x	a (a=0or1)	PnP	0	1	1	a
L	L	1	a (a=0or1)	PnP	0	0	1	a
L	L	0	x	RT jmpless	0	0	0	0

P.S. "x" denotes don't care.

The RTL8019AS's resource configuration informations such as I/O base address, BROM memory base address, and interrupt request line, etc., are stored in the CONFIG3-0 registers in Group1 Page3 as well as the PnP logical device configuration registers. Their power-up default values may come from the states of jumper pins in jumper mode or the contents of 9346 in PnP and RT jumperless mode. Their values can be modified by software via the logical device configuration registers in all 3 modes. The update values will be recorded to the CONFIG3-0 registers, too. This new configuration is only valid temporarily and will be lost after an auto-load command, an active RSTDRV, or PC power off . Permanent changes of configuration must be done by changing the jumper states or the contents of 9346. Note that the BROM size can not be modified temporarily.

The Plug and Play logic can work in all the three configuration modes except that an RT defined initiation key, named RT initiation key, should be used instead of the PnP initiation key. In other words, the RT initiation key is supported in all configuration modes while the PnP initiation key is only supported in the PnP mode. By using the RT initiation key, the software can put RTL8019AS to the PnP *Config* state and access the logical device configuration registers even in the jumper and RT jumperless modes.

Power up default ACTIVE state

In RTL8019, the ACTIVEB bit in 93C46 decides the power-up adapter status even in RT jumperless mode. In the standard application when BROM is not enabled, the adapter should be power up inactive in PnP mode and active in RT jumperless mode. However RTL8019's PnP jumper only decides the jumperless mode. The adapter's "ACTIVE" status is not changed properly at the same time when the user changes the PnP jumper state. This causes an application inconsistency when PnP jumper is to be used.

In RTL8019AS, we change RTL8019's original specification into:

The ACTIVEB bit in 9346 is ignored when RTL8019AS is in jumper or RT jumperless mode. The adapter's power-up status is always "ACTIVE" in RT jumperless mode. However, the active status still can be changed via the PnP Activate register.

The differences between the 3 configuration modes are shown in the following table.

Configuration Mode	Resource of Power-up Value	Supported Initiation Key
Jumper	Jumper Pins	RT Initiation Key
RT Jumperless	9346	RT Initiation Key
Plug and Play	9346	RT and PnP Initiation Key

Initial Values of CONFIG1-3 Registers after RSTDRV or Auto-load Command

CONFIG1

Mode	Bit 7	Bit 6	Bit 5	Bit 4	Bit 3	Bit 2	Bit 1	Bit 0
	IRQEN	IRQS2	IRQS1	IRQS0	IOS3	IOS2	IOS1	IOS0
Jumper	1	jumper	jumper	jumper	jumper	jumper	jumper	jumper
RT Jumperless Plug and Play	1	9346	9346	9346	9346	9346	9346	9346

CONFIG2

Mode	Bit 7	Bit 6	Bit 5	Bit 4	Bit 3	Bit 2	Bit 1	Bit 0
	PL1	PL0	BSELB	BS4	BS3	BS2	BS1	BS0
Jumper	jumper	jumper	0	jumper	jumper	jumper	jumper	jumper
RT Jumperless Plug and Play	9346	9346	0	9346	9346	9346	9346	9346

CONFIG3

Mode	Bit 7	Bit 6	Bit 5	Bit 4	Bit 3	Bit 2	Bit 1	Bit 0
	PNP	FUDUP	LEDS1	LEDS0	-	SLEEP	PWRDN	ACTIVEB
Jumper	0	9346	9346	9346	-	0	9346	9346
RT Jumperless Plug and Play	0 1	9346	9346	9346	-	0	9346	9346

6.2. Plug and Play

6.2.1. Initiation Key

The Plug and Play logic is quiescent on power up and must be enabled by software. This is done by a predefined series of writes (32 I/O writes) to the ADDRESS port, which is called the *initiation key*. The write sequence is decoded by RTL8019AS. If the proper series of I/O writes is detected, then the Plug and Play auto-configuration ports are enabled. The write sequence will be reset and must be issued from the beginning if any data mismatch occurs. The exact sequence for the initiation key is listed below in hexadecimal notation.

PnP Initiation Key

6A, B5, DA, ED, F6, FB, 7D, BE,
DF, 6F, 37, 1B, 0D, 86, C3, 61,
B0, 58, 2C, 16, 8B, 45, A2, D1,
E8, 74, 3A, 9D, CE, E7, 73, 39

RT Initiation Key

DA, 6D, 36, 1B, 8D, 46, 23, 91,
48, A4, D2, 69, 34, 9A, 4D, 26,
13, 89, 44, A2, 51, 28, 94, CA,
65, 32, 19, 0C, 86, 43, A1, 50

6.2.2. Isolation Protocol

A simple algorithm is used to isolate each Plug and Play card. This algorithm uses the signals on the ISA bus and requires lock-step operation between the Plug and Play hardware and the isolation software.

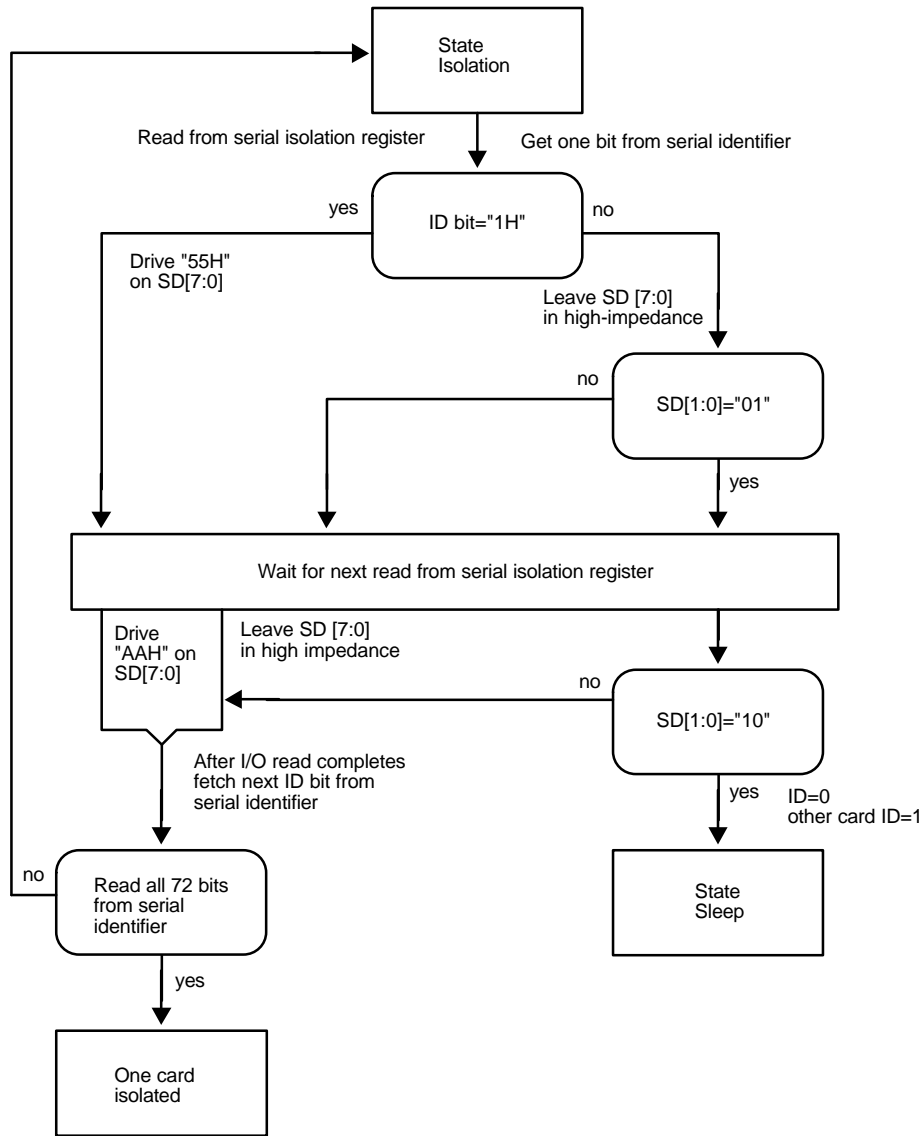

Figure 1. Plug and Play ISA Card Isolation Algorithm

Serial Identifier

The key element of the Plug and Play isolation protocol is that each card contains a unique number, named *serial identifier*. The serial identifier is a 72-bit unique, non-zero number composed of two 32-bit fields and an 8-bit checksum. The first 32-bit field is a vendor identifier. The other 32-bits can be any value, for example, a serial number, part of a LAN address, or a static number, as long as there will never be two cards in a single system with the same 64-bit number. The serial identifier is accessed bit-serially by the isolation logic and is used to differentiate the cards.

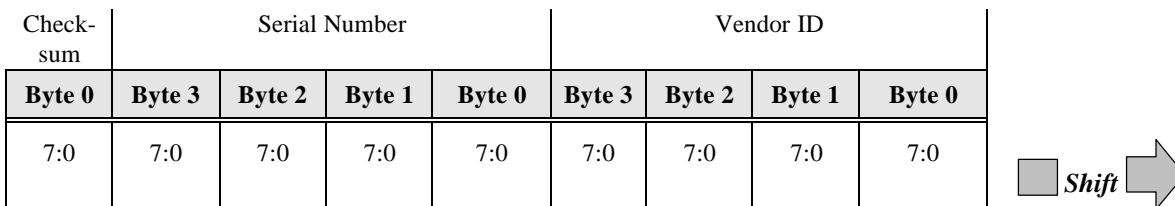

Figure 2. Shifting of Serial Identifier

The shift order for all Plug and Play serial isolation and resource data is defined as bit[0], bit[1], and so on through bit[7].

Hardware Protocol

The isolation protocol can be invoked by the Plug and Play software at any time. The initiation key described earlier, puts all cards into configuration mode. The hardware on each card expects 72 pairs of I/O read accesses to the READ_DATA port. The card's response to these reads depends on the value of each bit of the serial identifier which is being examined one bit at a time, in the sequence shown in Figure 1.

If the current bit of the serial identifier is a "1", then the card will drive the data bus to 55H to complete the first I/O read cycle. If the bit is "0", then the card puts its data bus driver into high impedance. All cards in high impedance will check the data bus during the I/O read cycle to sense if another card is driving SD[1:0] to "01". During the second I/O read, the card(s) that drove the 55H, will now drive a AAH. All high impedance card will check the data bus to sense if another card is driving SD[1:0] to "10."

If a high impedance card sensed another card driving the data bus with the appropriate data during both cycles, then that card ceases to participate in the current iteration of card isolation. Such cards, which lose out, will participate in future iterations of the isolation protocol.

NOTE: *During each read cycle, the Plug and Play hardware drives the entire 8-bit data bus, but only checks the lower 2 bits.*

If a card was driving the bus or if the card was in high impedance and did not sense another card driving the bus, then it should prepare for the next pair of I/O reads. The card shifts the serial identifier by one bit and uses the shifted bit to decide its response.

The above sequence is repeated for the entire 72-bit serial identifier.

At the end of this process, one card remains. This card is assigned a handle referred to as the *Card Select Number (CSN)* that will be used later to select the card. Cards which have been assigned a CSN will not participate in subsequent iterations of the isolation protocol. Cards must be assigned a CSN before they will respond to the other PnP commands.

It should be noted that the protocol permits the 8-bit checksum to be stored in non-volatile memory on the card or generated by the on-card logic in real-time. The checksum algorithm is implemented as a *Linear Feedback Shift Register (LFSR)*, which is shown in Figure 3.

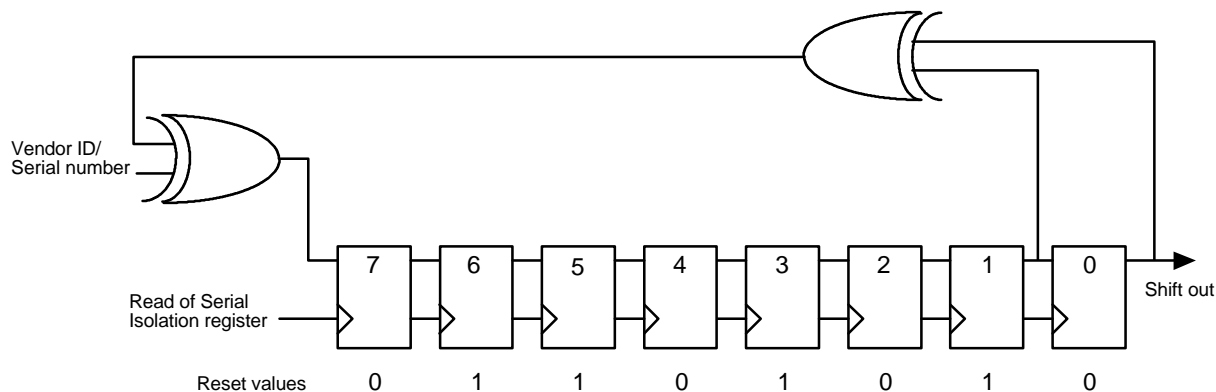

Figure 3. Checksum LFSR

The LFSR resets to 6AH upon receiving the Wake[CSN] command. The next shift value for the LFSR is calculated as $LFSR[1] \text{ XOR } LFSR[0] \text{ XOR } \text{Serial Data}$. The LFSR is shifted right one bit at the conclusion of each pair of reads to the Serial Isolation register. LFSR[7] is assigned the next shift value described above.

After the first 64 pairs of reads of the Serial Isolation register, the LFSR will have the value of serial identifier checksum.

Plug and Play cards must not drive the IOCHRDY signal during serial isolation. However, cards may drive IOCHRDY at any other time.

Software Protocol

The Plug and Play software sends the initiation key to all Plug and Play cards to place them into configuration mode. The software is then ready to perform the isolation protocol.

The Plug and Play software generates 72 pairs of I/O read cycles from the READ_DATA port. The software checks the data returned from each pair of I/O reads for the 55H or AAH driven by the hardware. If both 55H or AAH are read back, then the software assumes that the hardware had a "1" bit in that position. All other results are assumed to be a "0".

During the first 64 bits, software generates a checksum using the received data. The checksum is compared with the checksum read back in the last 8 bits of the sequence.

There are two other special considerations for the software protocol. During an iteration, it is possible that the 55H and AAH combination is never detected. It is also possible that the checksum does not match. If either of these cases occur on the first iteration, it must be assumed that the READ_DATA port is in conflict. If a conflict is detected, then the READ_DATA port is relocated. The above process is repeated until a non-conflicting location for the READ_DATA port is found. The entire range between 200H and 3FFH is available, however in practice it is expected that only a few locations will be tried before software determines that no Plug and Play cards are present.

During subsequent iterations, the occurrence of either of these two special cases should be interpreted as the absence of any further Plug and Play cards (i.e. the last card was found in the previous iteration). This terminates the isolation protocol.

NOTE: The software must delay 1 msec prior to starting the first pair of isolation reads, and must wait 250 msec between each subsequent pair of isolation reads. This delay gives the ISA card time to access information from possibly very slow storage devices.

6.2.3. Plug and Play Isolation Sequence

The Plug and Play isolation sequence is divided into four states: *Wait for Key*, *Sleep*, *Isolation*, and *Config* states. The state transitions for the Plug and Play ISA card are shown below.

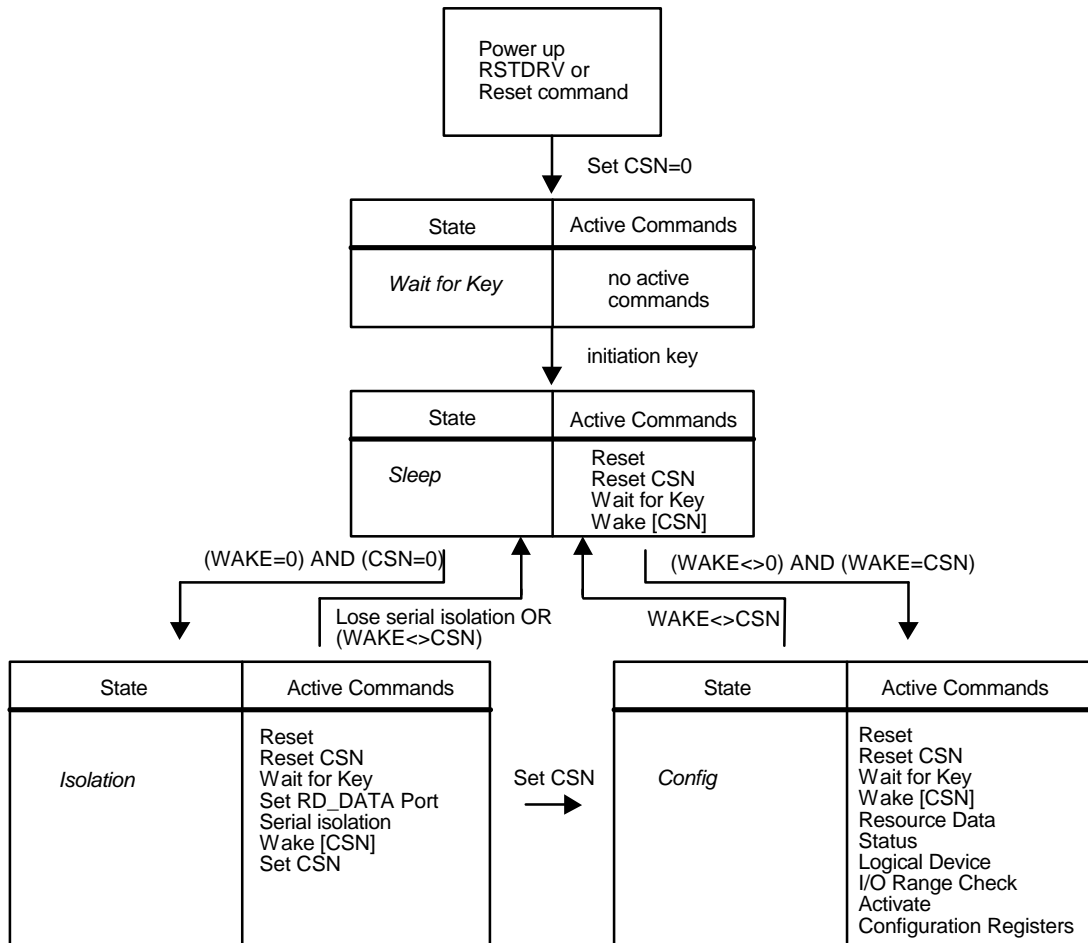

NOTES:

1. CSN= Card Select Number
2. RSTDRV causes a state transition from the current state to Wait for Key and sets all CSNs to zero
3. The Wait for Key command causes a state transition from the current state to Wait for Key
4. The Reset CSN commands include PnP Reset CSN and RT Reset CSN commands. The former sets all ISA PnP cards' CSNs to zero while the latter only sets RTL8019 PnP cards' CSNs to zero. Both commands do not cause a state transition.

Figure 4. Plug and Play ISA Card State Transitions

On power up, all PnP cards detect RSTDRV, set their CSN to 0, and enter the *Wait for Key* state. There is a required 2 msec delay from either a RSTDRV or a PnP Reset command to any Plug and Play port access to allow a card to load initial configuration information from a non-volatile device, which is 9346 for RTL8019AS.

Cards in the *Wait for Key* state do not respond to any access to their auto-configuration ports until the initiation key is detected. Cards ignore all ISA access to their Plug and Play interface.

When the cards have received the initiation key, they enter the *Sleep* state. In this state, the cards listen for a Wake[CSN] command with the write data set to 00H. This wake[CSN] command will send all cards to the *Isolation* state and reset the serial identifier/resource data pointer to the beginning.

The first time the cards enter the *Isolation* state it is necessary to set the READ_DATA port address using the Set RD_DATA port command. The software should then verify the selected READ_DATA port address is not in conflict with any other devices by the isolation protocol.

Next, 72 pairs of reads are performed to the Serial Isolation register to isolate a card as described previously. If the checksum read from the card is valid, then this means one card has been isolated. The isolated card remains in the *Isolation* state while all other cards have failed the isolation protocol and have returned to the *Sleep* state. The CSN on this card is set to a unique number. Writing this value causes this card to transition to the *Config* state. Sending a Wake[0] command causes this card to transition back to *Sleep* state and all cards with a CSN value of zero to transition to the Isolation state. This entire process is repeated until no Plug and Play cards are detected.

6.2.4. Reading Resource Data

Each PnP card supports a *resource data* structure stored in a non-volatile device (e.g. 9346) to describe the resources supported and those requested by the functions on the card. The Plug and Play resource management software will arbitrate resources and setup the logical device configuration registers according to the resource data.

Card resource data may only be read from cards in the *Config* state. A card may get to the *Config* state by one of two different methods. A card enters the *Config* state in response to the card "winning" the serial isolation protocol and having a CSN assigned. The card also enters the *Config* state in response to receiving a Wake[CSN] command that matches the card's CSN.

As described above, all Plug and Play cards function as if their serial identifier and their resource data both come from the same serial device. As also stated above, the pointer to the serial device is reset in response to any Wake[CSN] command. This implies that if a card enters the *Config* state directly in response to a Wake[CSN] command, the 9-byte serial identifier must be read first before the card resource data is accessed. The Vendor ID and Unique Serial Number is valid; however, the checksum byte, when read in this way, is not valid. A card that enters the *Config* state after the isolation protocol has been run has already accessed all 72 bits of the serial identifier and the first read of the Resource Data register will return resource data.

Card resource data is read by first polling the Status register and waiting for bit[0] to be set. When this bit is set it means that one byte of resource data is ready to be read from the Resource Data register. After the Resource Data register is read, the Status register must be polled before reading the next byte of resource data. This process is repeated until all resource data is read. The format of resource data is described in the following section.

The above operation implies that the hardware is responsible for accumulating 8 bits of data in the Resource Data register. When this operation is complete, the status bit[0] is set. When a read is performed on the Resource Data register, the status bit[0] is cleared, eight more bits are shifted into the Resource Data register, then the status bit[0] is set again.

6.2.5. PnP auto detect mode

When using RTL8019, the user needs to setup the card to PnP or jumperless mode according to the host environments. The typical operating modes of a RTL8019 card include:

- (1) when used in a non-PnP PC, set the card to RT jumperless mode & power-on active
- (2) when used in a PnP PC,
 - (2.1) if BROM disabled, set the card to PnP mode & power-on inactive
 - (2.2) if BROM enabled, set the card to PnP mode & power-on active

P.S. PCs with PnP BIOS, or Windows 95, or Intel Configuration Manager, etc. are called PnP PCs

If a card in mode(2.1) is put in a non-PnP PC, the drivers will fail to initialize the card. RTL8019AS supports a PnP auto-detect mode to solve the problem. ***The card may be set to a default state: PnP mode & power-on active with BROM disabled.*** If the card is in a non-PnP PC, it will work like a normal jumperless card. If the card is in a PnP PC which requires the card to be power-on inactive, RTL8019AS will change itself into inactive state when the first time a PnP init key is detected.

6.3. 9346 Contents

The 9346 is a 1k-bit EEPROM. Although it is actually addressed by words, we list its contents by bytes below for convenience.

Bytes		Contents	Comments
00H - 03H	(4 bytes)		Power-up initial value of Page3 and PnP logical device configuration registers
	00H	CONFIG1	
	01H	CONFIG2	
	02H	CONFIG3	
	03H	CONFIG4	
04H - 11H	(14 bytes)		NE2000 IDPROM
	04H - 09H	Ethernet ID 0-5	Ethernet node address
	0AH - 11H	Product ID 0-7	Assigned by card makers; negligible
12H - 1AH	(9 bytes)		Plug and Play Serial Identifier
	12H - 15H	Vendor ID 0-3	
	16H - 19H	Serial Number 0-3	
	1AH	Serial ID Checksum	
1BH - 7FH	(101 bytes)		Plug and Play Resource Data

Detail values of 9346 CONFIG1-3 bytes

	Bit 7	Bit 6	Bit 5	Bit 4	Bit 3	Bit 2	Bit 1	Bit 0
CONFIG1	*	IRQS2	IRQS1	IRQS0	IOS3	IOS2	IOS1	IOS0
CONFIG2	PL1	PL0	*	BS4	BS3	BS2	BS1	BS0
CONFIG3	PNP	FUDUP	LEDS1	LEDS0	*	*	PWRDN	ACTIVEB

P.S. '*' denotes don't care.

Example : Plug and Play Resource Data for RTL8019AS (Total 73+5 bytes)

TAG	Plug and Play Version Number	Length: fixed	3 bytes
	Item byte	0AH	
	PnP version	10H	
	Vendor version	10H	
TAG	ANSI Identifier String	Length: variable	37 bytes
	Item byte	82H	
	Length bits 7-0	22H	
	Length bits 15-8	00H	
	Identifier string	'REALTEK PLUG & PLAY ETHERNET CARD', 00H	
TAG	Logical Device ID	Length: fixed	7 bytes
	Item byte	16H	
	Logical device ID0-3	4AH, 8CH, 80H, 19H	
	Flag 0	02H or 03H (use 03H when BROM is enabled)	
	Flag 1	00H	
TAG	Compatible Device ID (NE2000 compatible)	Length: fixed	5 bytes if given

	Item byte	1CH		
	Compatible ID0-3	41H, D0H, 80H, D6H		
TAG	I/O Format		Length: fixed	8 bytes
	Item byte	47H		
	I/O information	00H		
	Min. I/O base bits 7-0	20H		
	Min. I/O base bits 15-8	02H		
	Max. I/O base bits 7-0	80H		
	Max. I/O base bits 15-8	03H		
	Base alignment	20H		
	Range length	20H		
TAG	IRQ Format		Length: fixed	4 bytes
	Item byte	23H		
	IRQ mask bits 7-0	38H		
	IRQ mask bits 15-8	9EH		
	IRQ information	01H		
TAG	Memory Format (optional)		Length: fixed	12 bytes
	Item byte	81H	This example uses 16k-byte BROM.	
	Length bits 7-0	09H		
	Length bits 15-8	00H		
	Memory information	40H		
	Min. base bits 15-8	00H		
	Min. base bits 23-16	0CH		
	Max. base bits 15-8	C0H		
	Max. base bits 23-16	0DH		
	Base alignment bits 7-0	00H		
	Base alignment bits 15-8	40H		
	Range length bits 15-8	40H		
	Range length bits 23-16	00H		
TAG	END Tag		Length: fixed	2 bytes
	Item byte	79H		
	Checksum	2's complement of the sum of all the above resource data i.e. 2's complement of (0AH+10H+10H+.....+79H)		

6.4. Boot ROM

Whether a EPROM or flash memory is used as the BROM, RTL8019AS's BROM read operation is still the same as RTL8019's. The supported BROM size is the same, too.

The write operation of a flash memory is much like the read except that a SMEMWB command is issued instead of SMEMRB. The block diagram below shows the application when an 128k*8bit flash memory (e.g. 29F010) is used as the BROM.

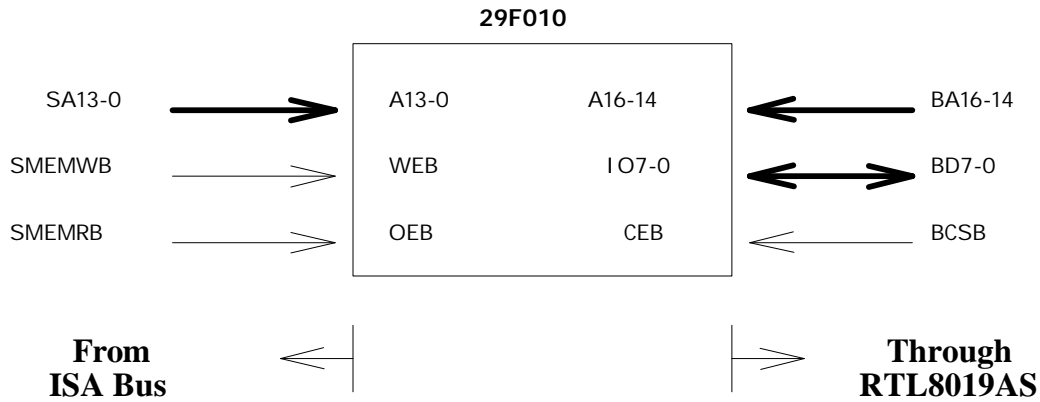

In this case, the BROM page mode is used. Before either to read or write BROM, the appropriate ROM page must be set in the BPAGE (page3, offset 02h) register first. The RTL8019AS will always reflect the content of BPAGE onto the BA14-21 bus. When RTL8019AS decodes a valid BROM read or write command, it asserts BCSB low. Note the flash memory write must be enabled through the RTL8019AS's FMWP register before the host's flash write command.

6.5. LED Behaviors

This section describes the lighting behaviors of the LED output signals which may be selected by LEDS1 and LEDS0 bits in the Page3 CONFIG3 register.

P.S. It is assumed that the LED is on when the signal goes low.

(1) LED_TX: Tx LED

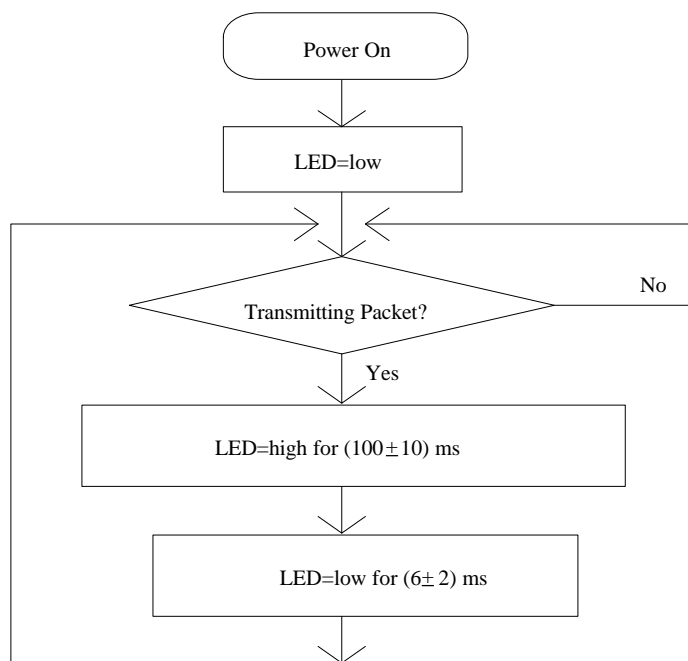

(2) LED_RX: Rx LED

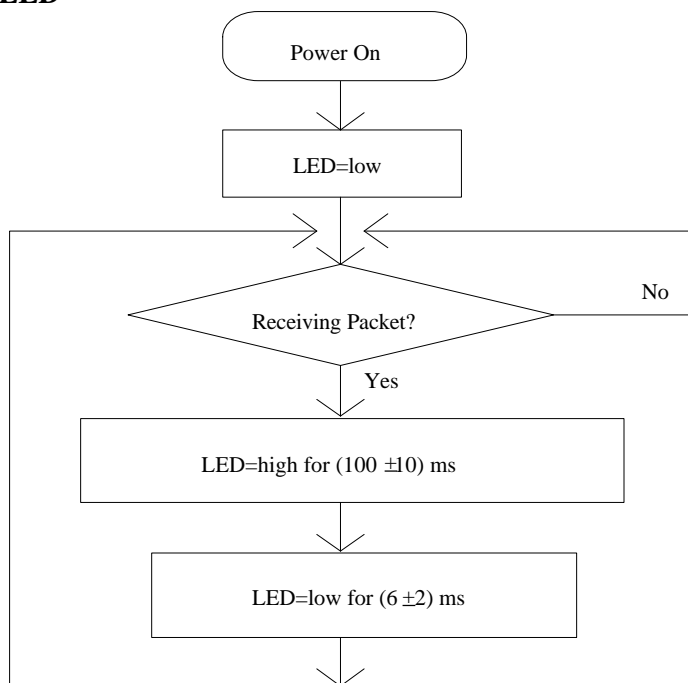

(3) LED_CRS=LED_TX+LED_RX: Carrier Sense LED

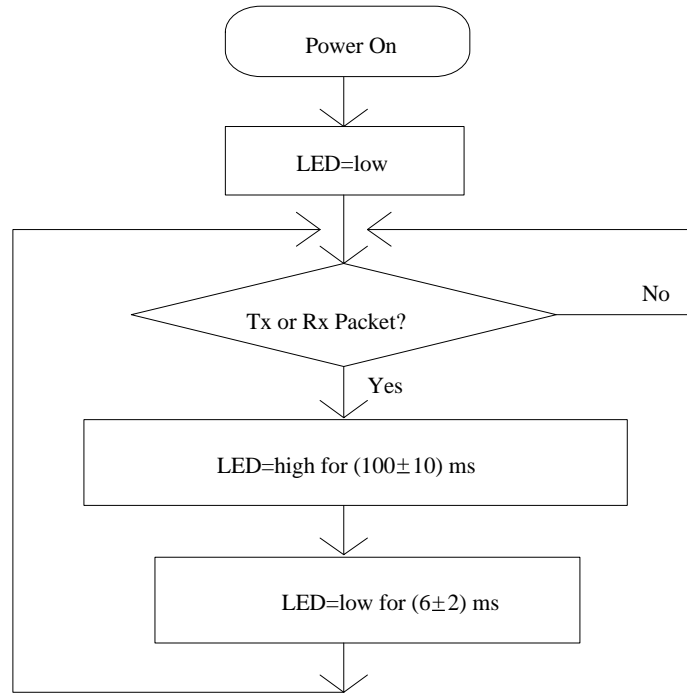

(4) LED_COL: Collision LED

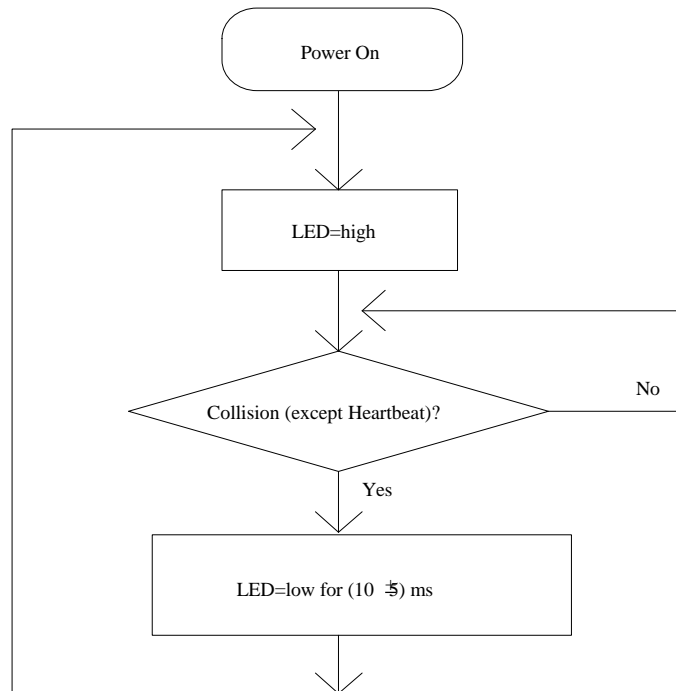

LED1 (LED_RX or LED_CRIS)

RTL8019's LED_RX or LED_CRIS LED sometimes keeps blinking when the media type of a 2-in-1 (UTP+BNC) LAN adapter is set to auto-detect and both UTP and coaxial cable are not connected. In the case, RTL8019 is actually using the BNC because the UTP link test fails. Many 8392 will falsely detect a carrier when the BNC interface is not properly terminated (e.g. coaxial cable is not connected). That carrier sense will then make RTL8019's LED_RX or LED_CRIS blink. The problem is that not all 8392s cause the LED blinking, which makes the phenomenon very ambiguous. Considering the phenomenon is normally awared upon power on, we change RTL8019's original function to solve the problem to some extent.

The new specification is:

The LED_RX or LED_CRIS does not reflect the carrier sense when the CR register bit 0 is set (in stop mode). Thus, the false carrier due to cabling problem upon power on will not cause the LED1 to blink anymore.

LED Output States in Power Down Modes

LED Output	Normal Mode / Idle	Sleep Mode	Power Down Mode
LEDBNC	-	-	Low
LED_LINK	-	High	High
LED_COL	High	High	High
LED_TX	Low	High	High
LED_RX	Low	High	High
LED_CRIS	Low	High	High

6.6. Loopback Diagnostic Operation

6.6.1. Loopback operation

The RTL8019AS provides 3 loopback modes. By loopback test, we can verify the integrity of data path, CRC logic, address recognition logic and cable connection status.

Mode 1: Loopback through the NIC (LB1=0, LB0=1 in TCR).

The NRZ data is not transmitted to the SNI but instead it's loopbacked to the NIC's Rx deserializer. The traffic on the cable is ignored.

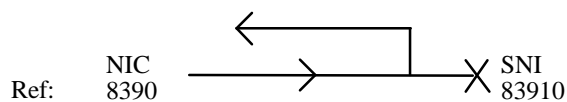

Mode 2: Loopback through the SNI (LB1=1, LB0=0 in TCR)

The Manchester encoded data is not transmitted to the MAU. It's loopbacked through the SNI to NIC. The traffic on the cable is ignored.

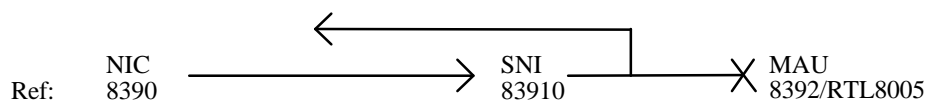

Mode 3: Loopback through the cable (LB1=1, LB0=1 in TCR)

The packets are transmitted via the MAU onto the network and RTL8009 receives all incoming packets (not only the MAU-loopbacked Tx data) in the meantime.

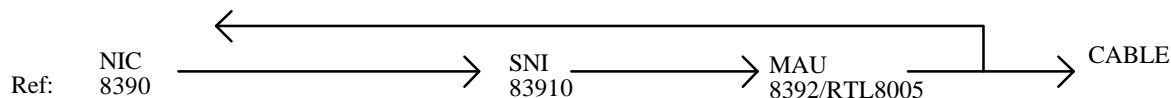

Alignment of the Reception FIFO

The reception FIFO is an 8-byte ring structure. The first received byte is put at location zero. When the location pointer goes to the end of the FIFO, it wraps to the beginning of the FIFO and overwrites the previous data. At the end of the packet reception, the FIFO contents are in the "order" (from the ring structure's view) as shown below.

(1) CRC enabled (CRC bit in TCR=0)

- 1-byte received packet data
- 4-byte CRC
- 1-byte lower byte count
- 1-byte upper byte count
- 1-byte upper byte count

(2) CRC disabled (CRC bit in TCR=1)

- 5-byte received packet data
- 1-byte lower byte count
- 1-byte upper byte count
- 1-byte upper byte count

6.6.2. To Implement Loopback Test

(1) To verify the integrity of data path

- set RCR=00h to accept physical packet
- set PAR0-5 to accept packet
- set DCR=40h (8-bit slot) or 43h (16-bit slot)
- set TCR=02h, 04h, 06h to do loopback test 1, 2, 3 respectively
- set CRC enabled (CRC=0 in TCR)
- clear ISR
- tx a packet and check ISR
- check FIFO after loopback

Note: Loopback mode 3 is sensitive to the network traffic, so the values of FIFO may be not correct.

(2) To verify CRC logic

Select a loopback mode (e.g. mode 2) to test

A. To test CRC generator

- set RCR=00h to accept physical packet

set PAR0-5 to accept packet
set TCR=04h (CRC enabled)
set DCR=40h (8-bit slot) or 43h (16-bit slot)
clear ISR
tx a packet
check CRC bytes in FIFO after loopback

B. To test CRC checker

set RCR=00h to accept physical packet
set PAR0-5 to accept packet
set TCR=05h (CRC disabled)
set DCR=40h (8-bit slot) or 43h (16-bit slot)
clear ISR
tx a packet with good or bad CRC appended by program
check FIFO, ISR & RSR after loopback
For bad CRC, expected: ISR=06h, RSR=02h (Tx: OK, Rx:CRC error)
For good CRC, expected: ISR=02h, RSR=01h (Tx:OK, Rx: OK)

Note: In loopback mode, the received packets are not stored to SRAM, so PRX bit in ISR isn't set.

(3) To verify the address recognition function

Select a loopback mode (e.g. mode 2) to test

A. Right physical destination address

set RCR=00h to accept physical packet
set PAR0-5 to accept packet
set TCR=04h (CRC enabled)
set DCR=40h (8-bit slot) or 43h (16-bit slot)
clear ISR
tx a packet
check ISR after loopback
Expected: ISR=06h (packets accepted, Rx CRC error)

B. Wrong physical destination address

set RCR=00h to accept physical packet
set PAR0-5 to reject packet
set TCR=04h (CRC enabled)
set DCR=40h (8-bit slot) or 43h (16-bit slot)
clear ISR
tx a packet
check ISR after loopback
Expected: ISR=02h (packets rejected, Rx no response)

(4) To Test Cable Connection

There are four physical medium types in RTL8019.

We perform loopback mode 3 to test the cable connection status.

set RCR=00h to accept physical packet
set PAR0-5 to accept packet
set TCR=06h (CRC enabled)
set DCR=40h (8-bit slot) or 43h (16-bit slot)
clear ISR
tx a packet
check TSR after loopback

A. 10Base2

If cable OK, get TSR=03h (Tx OK).
If cable FAIL, get TSR=0Eh (Collision and Tx aborted).

B. 10Base5

If cable OK, get TSR=03h (Tx OK).
If MAU connected but cable FAIL, get TSR=0Eh (Tx collision and Tx aborted).
If MAU not connected, get TSR=53h (Carrier sense is lost during transmission and CD heartbeat fails.).

C. 10BaseT with link test disabled

RTL8019AS disables link test in this case, so cable OK or FAIL doesn't affect TSR; get TSR=03h.

D. Auto-detection (10BaseT with link test enabled)

RTL8019AS automatically switches from 10BaseT to 10Base 2 if the twisted-pair wire is not connected (10BaseT link test fails).

If twisted-pair wire OK, get TSR=03h (Tx OK) & BNC=0 in CONFIG2
If twisted-pair wire FAIL but coaxial cable OK, get TSR=03h (Tx OK) & BNC=1 in CONFIG2
Otherwise, get TSR=0Eh (same as 10Base2 connection fail).

7. Electrical Specifications and Timings

7.1. Absolute Maximum Ratings

Operating Temperature 0 to 70
 Storage Temperature -65 to 140
 All Outputs and Supply Voltages, with respect to Ground -0.5V to 7V
 Power Dissipation

Warning:

Stresses beyond those listed under "Absolute Maximum Ratings" may cause permanent damage to the device. These are stress ratings only.

Functionality at or above these limits is not recommended and extended exposure to "Absolute Maximum Ratings" may affect device reliability.

7.2. D.C. Characteristics (Tc=0 to 70 , Vcc=5V±5%)

Symbol	Parameter	Min.	Typ.	Max.	Unit	Conditions
Vil	Input Low Voltage			0.8	V	
Vih	Input High Voltage	2.0			V	
Vol1	Output Low Voltage 1		0.4	0.6	V	Iol=16mA, Note 1
Voh1	Output High Voltage 1	3.0	3.5		V	Ioh=8mA, Note 1
Vol2	Output Low Voltage 2		0.4	0.6	V	Iol=4mA, Note 2
Voh2	Output High Voltage 2	3.5	4.0		V	Ioh=4mA, Note 2
Vol3	Output Low Voltage 3			0.6	V	Iol=24mA, Note 3
Rpull-low	Internal Pull-Low Resistance	50	100	150	KW	
Ii	Input Leakage Current	-10		10	mA	

Note 1: Apply only to INT7 ~ INT0, SD15 ~ SD0.

Note 2: Apply only to MD7 ~ MD0, MA13 ~ MA0, LED Pins, EECS, MWRB, MRDB, BCSB.

Note 3: Apply only to IOCHRDY, IOCS16B

7.3. A.C. Timing Characteristics

(1) ISA I/O Read/Write

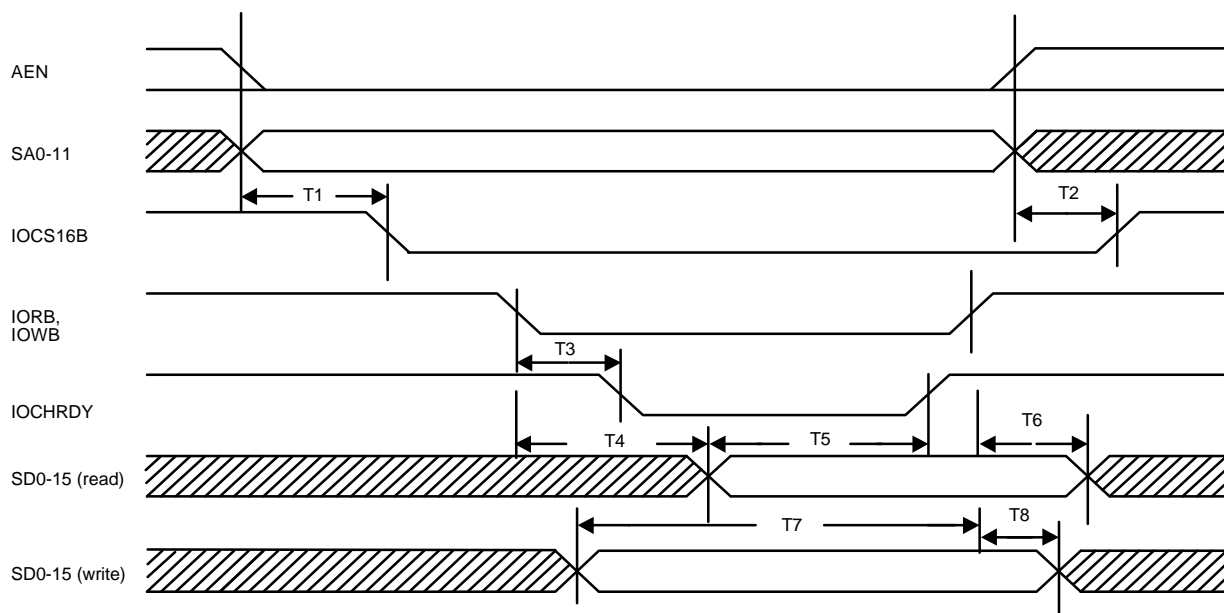

Symbol	Parameter	Min.	Typ.	Max.	Unit
T1	Host address valid to IOCS16B low	8	20	20	ns
T2	Host address invalid to IOCS16B high	4	30	--	ns
T3	IOCHRDY goes low from falling edge of IORB or IOWB when wait state insertion is needed.	--	50	50	ns
T4	Read data valid from falling edge of IORB or IOWB when no wait state insertion is needed.	--	50	60	ns
T5	Read data valid to IOCHRDY high when wait state is needed	25	--	--	ns
T6	Read data hold after IORB rising edge	10	30	30	ns
T7	Write data setup to IOWB rising edge	10	10	--	ns
T8	Write data hold from IOWB rising edge	10	10	--	ns

(2) BROM Read

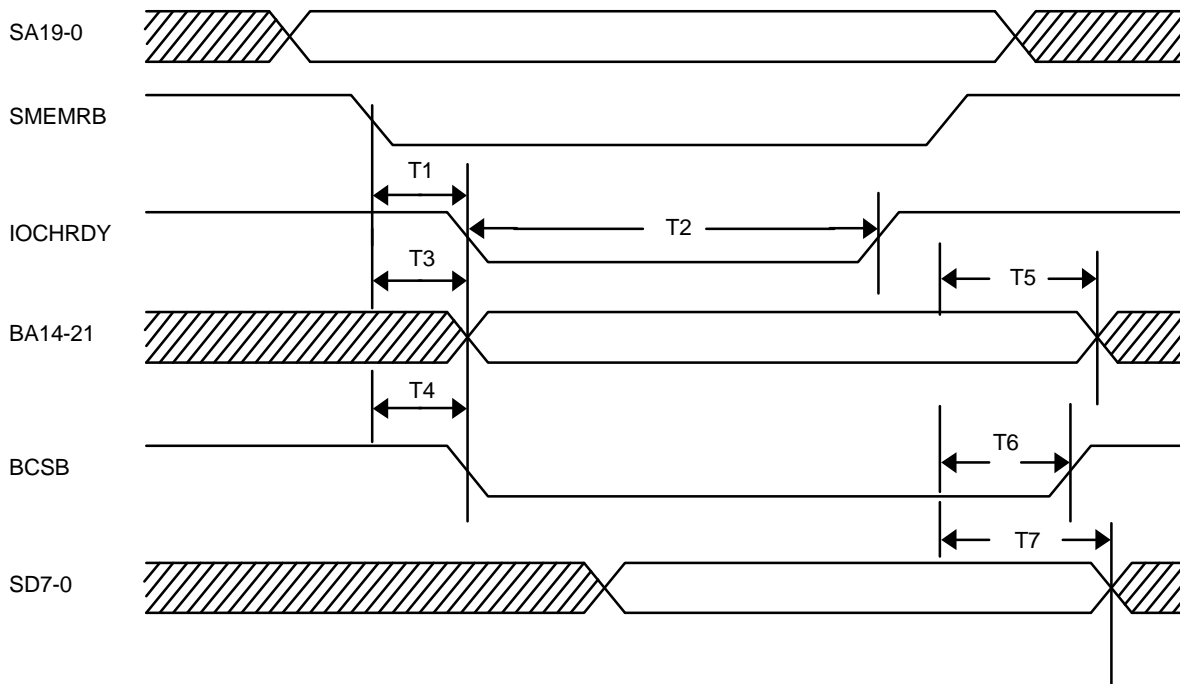

Symbol	Parameter	Min.	Typ.	Max.	Unit
T1	SMEMRB low to IOCHRDY low	-	-	30	ns
T2	IOCHRDY low width	125	200	350	ns
T3	SMEMRB low to BA14-21 valid	-	-	30	ns
T4	SMEMRB low to BCSB valid	-	-	30	ns
T5	BA14-21 hold from SMEMRB rising edge	-	-	30	ns
T6	BCSB hold from SMEMRB rising edge	-	-	30	ns
T7	Read data hold from SMEMRB rising edge	-	-	30	ns

(3) Serial EEPROM (9346) Auto-load

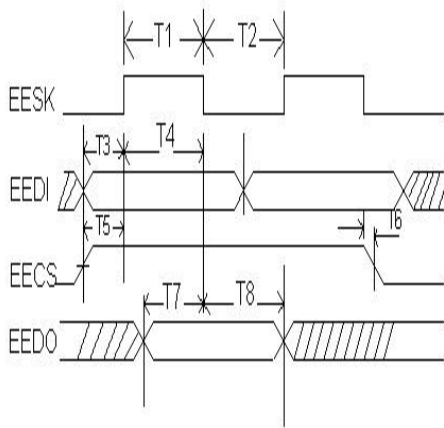
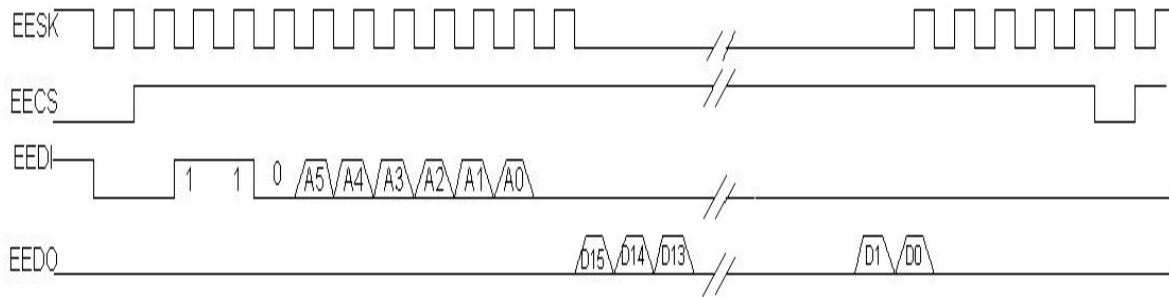

Symbol	Parameter	Min.	Typ.	Max.	Unit
T1	EESK high width	-	3.2	-	ms
T2	EESK low width	-	3.2	-	ms
T3	EEDI setup to EESK rising edge	3.0	-	-	ms
T4	EEDI hold from EESK rising edge	3.0	-	-	ms
T5	EECS goes high to EESK rising edge	3.0	-	-	ms
T6	EECS goes low from EESK falling edge	-	0	-	ns
T7	EEDO setup to EESK falling edge	20	-	-	ns
T8	EEDO hold from EESK falling edge	10	-	-	ns

REALTEK Semiconductor Co., Ltd. reserved all rights of this document. No part of this document may be copied or reproduced in any form or by any means or transferred to any third party without the prior written consent of **REALTEK Semiconductor Co., Ltd.** REALTEK reserves the right to change products or specifications without notice. This document has been carefully checked and is believed to be accurate. However **REALTEK Semiconductor Co., Ltd.** assumes no responsibility for inaccuracies.

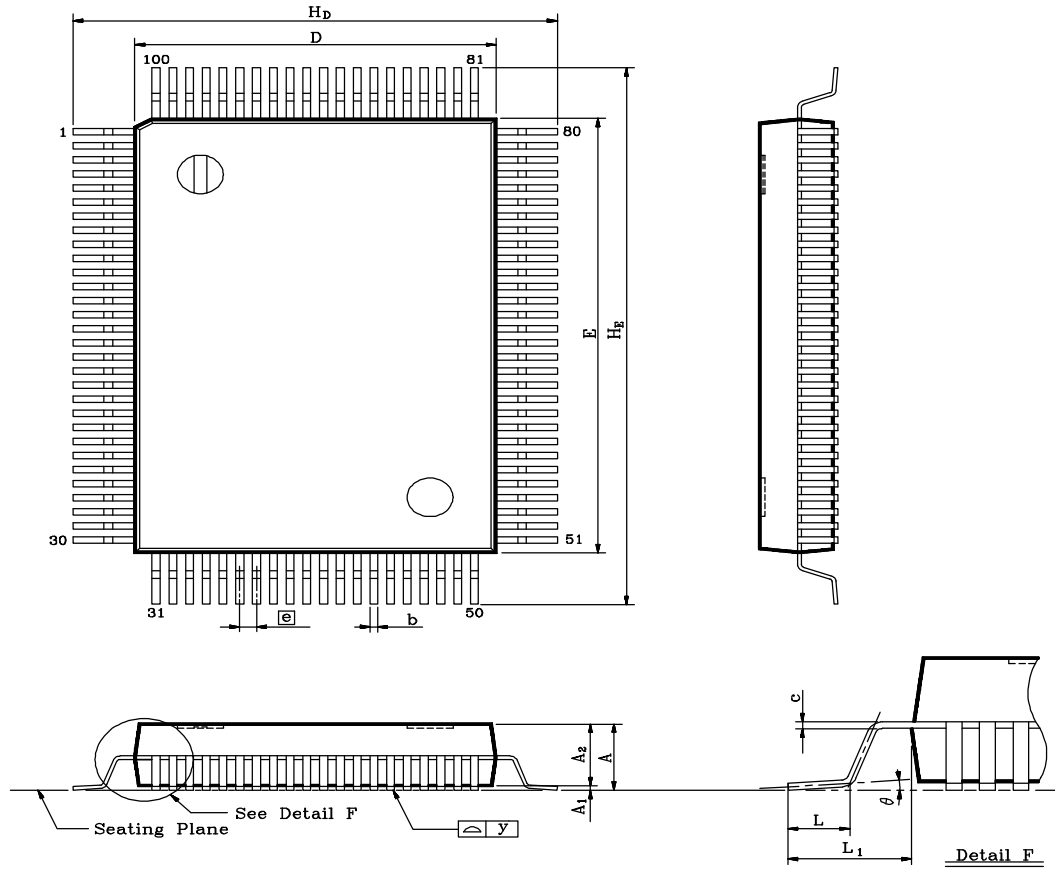

Note:

- 1.Dimension D & E do not include interlead flash.
- 2.Dimension b does not include dambar protrusion/intrusion.
- 3. Controlling dimension: Millimeter**
- 4.General appearance spec. should be based on final visual inspection spec.

Symbol	Dimension in mil			Dimension in mm		
	Min	Typ	Max	Min	Typ	Max
A	106.3	118.1	129.9	2.70	3.00	3.30
A₁	4.3	20.1	35.8	0.11	0.51	0.91
A₂	102.4	112.2	122.0	2.60	2.85	3.10
b	7.1	11.8	16.5	0.18	0.30	0.42
c	1.6	5.9	10.2	0.04	0.15	0.26
D	541.3	551.2	561.0	13.75	14.00	14.25
E	777.6	787.4	797.2	19.75	20.00	20.25
e	19.7	25.6	31.5	0.50	0.65	0.80
H_D	726.4	740.2	753.9	18.45	18.80	19.15
H_E	962.6	976.4	990.2	24.45	24.80	25.15
L	39.4	47.2	55.1	1.00	1.20	1.40
L₁	88.6	94.5	104.3	2.25	2.40	2.65
y			3.9			0.10
	0°		12°	0°		12°

TITLE : 100L QFP (14x20 mm**2) FOOTPRINT 4.8 mm			
PACKAGE OUTLINE DRAWING			
LEADFRAME MATERIAL:			
APPROVE		DWG NO.	
		REV NO.	
		SCALE	
CHECK	Ricardo Chen	DATE	
		SHT NO.	1 OF
REALTEK SEMI-CONDUCTOR CO., LTD			